Avedro, Inc. KXL System

Operator's Manual



Copyright 2020. All Rights Reserved.
Printed in U.S.A.

Patents, Trademarks, Copyrights

The KXL System may be covered by one or more patent applications issued or pending in the United States and worldwide.

“KXL” and the Avedro logo design are registered trademarks or trademarks of Avedro, Inc. All software and documentation is subject to Avedro, Inc. copyrights. All rights reserved 2020.

Microsoft and Windows are registered trademarks and trademarks, respectively, of Microsoft Corporation. Any other trademarks or service marks contained within this manual are the property of their respective owners.

For more information, contact:

Your Local Avedro-authorized distributor



Avedro, Inc.
201 Jones Road
Waltham, MA 02451



EMERGO EUROPE
Prinsessegracht 20
2514 AP, The Hague
The Netherlands
Phone: +31.70.345.8570
Fax: +31.70.346.7299



Table of Contents

Foreword	1
1.1	Intended Use of Manual.....1
1.2	Intended Use / Indications for Use.....1
1.3	Design Change Disclaimer.....1
1.4	Reproduction Disclaimer.....1
1.5	User Operation Assistance Statement.....2
1.6	Contraindications, Warnings and Cautions.....2
1.6.1	Contraindications.....2
1.6.2	Warnings.....2
1.6.3	Electrical Safety Warnings.....2
1.7	Radiation Safety Warnings.....5
1.8	Patient Safety.....5
1.9	Additional Safety Considerations.....5
1.10	FCC Compliance Notice.....6
2 Introduction	7
2.1	System Overview.....7
2.1.1	Major Components.....8
3 System Operation	11
3.1	Touchpad/Keyboard Use.....11
3.2	UV Energy (Dose).....13
3.3	Preparing the System.....14
3.4	Important Steps before Turning On the System.....14
3.5	Powering Up the System.....14
3.6	Existing Patient Data.....15
3.7	Add New Patient.....16
3.8	Create New Treatment Plan.....17
3.8.1	Select Eye to Treat.....17
3.8.2	Selecting a KXL Default Treatment Type.....18
3.8.3	Custom Treatment Plans.....18
3.8.4	Modifying Custom Treatment Parameters.....19
3.9	Starting a Treatment.....20
3.9.1	Insert Treatment / RFID Activation Card.....20
3.9.2	Single-use Activation Cards.....21
3.9.3	Multi-use Activation Cards.....22
3.9.4	RFID Card-controlled Limits.....23
3.9.5	Sync Alignment Remote.....24
3.10	Preparing the Patient.....26
3.10.1	Applying Riboflavin, Induction, and Alignment.....27
3.11	Initiating Treatment.....29
3.12	Monitoring Treatment.....29
3.13	Pausing a Treatment.....30
3.14	Cancelling Mid-Treatment.....31
3.15	Capturing Images.....32
3.16	Treatment Complete.....33
3.17	Reviewing Images.....33

3.18	Deleting Photos.....	33
3.19	Patient Treatment Report.....	35
	3.19.1 Adding Notes to a Patient Treatment Report	36
	3.19.2 Exporting Treatment Report.....	37
	3.19.3 Viewing a Treatment Report.....	39
3.20	Powering Down the KXL System.....	43
3.21	Accessing the Options Menu.....	44
	3.21.1 Manage Clinic Preset Plans	44
	3.21.2 System Settings Menu	45
	3.21.3 System Settings - Altering the System Volume	46
	3.21.4 System Settings - Altering Camera White Balance	46
	3.21.5 System Settings - Altering Alignment Crosshairs' Intensity.....	47
	3.21.6 System Settings - Selecting a Different System Language.....	47
	3.21.7 System Settings - Export Service Log.....	48
	3.21.8 System Settings - Backing up and Restoring Patient Data	48
	3.21.9 System Settings - Clinic Preset Display Priority	49
	3.21.10 Service Settings	49
	3.21.11 Demo Mode.....	49
4	Maintenance / Service	51
4.1	Installation Policy.....	51
4.2	Customer Maintenance.....	51
4.3	Warranty Information.....	51
4.4	Service Contract Information.....	51
4.5	Per Patient Disposables.....	51
4.6	Trouble Shooting.....	52
	4.6.1 Wireless Remote	52
4.7	Directions for Disinfection	55
4.8	Cleaning the System	55
4.9	Cleaning the Aperture	56
4.10	Articulating Arm Adjustment	56
4.11	Moving the System.....	58
4.12	Storing the System.....	59
4.13	Software.....	59
4.14	Risks Associated with Disposing of Waste Products.....	59
4.15	Performing a Visible Check	59
5	Equipment Classification	60
6	Symbol Library.....	67
7	Specifications.....	69

Table of Figures

Figure 2-1. Overview Illustration of System.....	8
Figure 2-2. System Illustrations with Callouts.....	9
Figure 2-3. Wireless Remote.....	9
Figure 2-4. KXL Label	10
Figure 2-5. UV emitting Label.....	10
Figure 2-6. Laser Classification Label.....	10
Figure 3-1. Power Switch.....	14
Figure 3-2. Patient Database.....	15
Figure 3-3. Enter Patient Information.....	16
Figure 3-4. Create New Treatment Plan	17
Figure 3-5. Select Eye.....	17
Figure 3-6. Perform a Default Treatment Plan	18
Figure 3-7. Save Clinic Preset Treatment Plan	19
Figure 3-8. Custom Treatment Plan - Continuous UV Mode	20
Figure 3-9. Insert KXL Activation Card.....	21
Figure 3-10. Reading Activation Card	21
Figure 3-11. Card Treatment Balance	22
Figure 3-12. Card Balance: Treatments Remaining	22
Figure 3-13. No Treatments Left.....	23
Figure 3-14. Invalid Treatment Parameters	23
Figure 3-15. Invalid Treatment Parameters	24
Figure 3-16. Sync Remote.....	24
Figure 3-17. System Setup Status.....	25
Figure 3-18. Sync Process Timed Out.....	25
Figure 3-19. Remote Indicator Light Status and Meaning.....	26
Figure 3-20. Remote Indicator Light Status and Meaning	26
Figure 3-21. Prepare For Treatment: Apply riboflavin	27
Figure 3-22. Align Crosshairs During Induction	27
Figure 3-23. Alignment of Red Crosshairs - X & Y Axes and Z Axis.....	28
Figure 3-24. Remote Functions	28
Figure 3-25. Start UV Treatment.....	29
Figure 3-26. Treatment in Progress Screen.....	30
Figure 3-27. Treatment Paused Screen.....	30
Figure 3-28. Confirm Cancel Partial Treatment.....	31
Figure 3-29. Treatment Cancelled Confirmation	31
Figure 3-30. Partial Treatment Not Completed.....	32
Figure 3-31. Capturing Images.....	32
Figure 3-32. Treatment Complete Screen.....	33
Figure 3-33. Select Trash to delete	34
Figure 3-34. Select Yes to Delete	34
Figure 3-35. Select Done	35
Figure 3-36. Sample Treatment Report.....	36
Figure 3-37. Comments Icon.....	36
Figure 3-38. Comments Section.....	37
Figure 3-39. Exporting Treatment Report.....	37
Figure 3-40. Insert USB.....	38
Figure 3-41. USB Error and No Space Left on USB	38
Figure 3-42. Generating treatment report	38

Figure 3-43. Treatment report exported	39
Figure 3-44. Page 1 of 3: Treatment Details.....	40
Figure 3-45. Page 2 of 3: Comments.....	41
Figure 3-46. Page 3 of 3: Photos.....	42
Figure 3-47. Select “Power Off”.....	43
Figure 3-48. Confirm “Power Off”.....	43
Figure 3-49. Power Off Position.....	44
Figure 3-50. Press the “Options” button.....	44
Figure 3-51. Manage Clinic Preset Plans	45
Figure 3-52. System Settings Menu	45
Figure 3-53. Edit Volume.....	46
Figure 3-54. Edit Camera White Balance.....	46
Figure 3-55. Alignment Crosshairs Intensity.....	47
Figure 3-56. Edit System Language.....	47
Figure 3-57. Export Service Log to USB.....	48
Figure 3-58. Export Service Log in Progress	48
Figure 3-59. Clinic Preset Display Priority.....	49
Figure 3-60. Patient List Indicates Demo Mode	50
Figure 3-61. Demo Mode is Indicated at Top of Screen.....	50
Figure 4-1. Access Battery Compartment	52
Figure 4-2. Alignment Remote Lost Sync - Original Remote.....	53
Figure 4-3. Alignment Remote Lost Sync - Updated Remote.....	54
Figure 4-4. Position the Arm Parallel to the Floor	56
Figure 4-5. Loosen Counterbalance Set Screw A.....	56
Figure 4-6. Loosen Counterbalance Set Screw B.....	57
Figure 4-7. Set Arm Tension with Strength Adjustment Screw C.....	57
Figure 4-8. Moving System Configuration	58

Foreword

1.1 Intended Use of Manual

This manual is designed to serve the operators of the Avedro, Inc. KXL System. All operating instructions, product illustrations, screen graphics, troubleshooting/error messages, and other relevant information are contained in this manual. It is the operator's responsibility to ensure that all safety instructions in this manual are applied strictly.

1.2 Intended Use / Indications for Use

The KXL System delivers a uniform, metered dose of UVA light to a targeted treatment area for the intended use of illuminating the cornea during corneal cross-linking procedures stabilizing cornea which have been weakened by disease or by refractive surgery.

1.3 Design Change Disclaimer

- Due to design changes and product improvements, information in this manual is subject to change without notice. Avedro, Inc. (hereafter called "Avedro") reserves the right to change product design at any time without notice, which may subsequently affect the contents of this manual.
- Avedro assumes no responsibility for any errors that may appear in this manual. Avedro will make every reasonable effort to ensure that this manual is up to date and corresponds with the shipped KXL System.
- The computer display screens depicted in this manual are representative only. Depending on the software version of the system, minor differences may appear between the actual computer displays and those shown in this manual.
- All patient data appearing in this document, including the sample screen graphics, are fictitious and representative only. No patient's confidentiality has been violated, with or without permission.

1.4 Reproduction Disclaimer

Neither this manual nor any part of it may be reproduced, photocopied, or electronically transmitted in any way without the advanced written permission of Avedro, Inc.

1.5 User Operation Assistance Statement

Should you experience any difficulty in running your KXL System, please contact your local Avedro authorized representative.

1.6 Contraindications, Warnings and Cautions

1.6.1 Contraindications

This section describes situations in which the device should not be used because the risk of use clearly outweighs any possible benefit. Conditions that may contraindicate the use of the device include:

- Corneal thickness, with epithelium, of less than < 375 microns.
- Corneal melting disorders
- Aphakic patients
- Pseudophakic patients without UV blocking lens implanted
- Pregnant and nursing women
- Children

1.6.2 Warnings

Physicians should evaluate the potential benefits in patients with the following conditions:

- Herpes simplex, herpes zoster keratitis, recurrent corneal erosion, corneal dystrophy
- Epithelial healing disorders
- In this manual, Caution is defined as: a statement that alerts the user to the possibility of a problem with the device associated with its use or misuse. Such problems include device malfunction, device failure, damage to the device or damage to other property. The caution statement includes the precaution that should be taken to avoid the hazard.
- In this manual, Warning is defined as: a statement that alerts the user to the possibility of injury, death, or other serious adverse reactions associated with the use or misuse of the device.

1.6.3 Electrical Safety Warnings

- This equipment requires special precautions regarding electromagnetic compatibility (EMC). Installation and use should be carried out according to the EMC information provided in this manual.

- Portable and mobile RF communications equipment can affect medical electrical equipment such as the Avedro KXL System.

For Equipment Classifications please refer to Chapter 5.0 Equipment Classifications.



WARNING: Any repair or service must be carried out by Avedro trained personnel only.

WARNING: Do NOT modify this equipment without authorization of the manufacturer.



WARNING: To avoid the risk of shock this equipment must only be connected to a supply mains with protective earth.

To separate system connection to mains, grasp the power cord plug and pull it from outlet to disconnect.

The system is designed for continuous operation using the external connector.



WARNING: This equipment is operated with hazardous voltages that can shock, burn, or cause death. To reduce the possibility of electrical shock, and inadvertent UVA exposure do not remove any fixed panels. Ensure that all service to the system, beyond what is described in this manual, is performed only by qualified Avedro authorized service personnel.



WARNING: Power down system and remove the wall plug before servicing or cleaning (disinfecting) the equipment.



Never pull cords to remove the power cord from the outlet.

Grasp the power cord plug and pull it from the outlet to disconnect.

The equipment must be positioned so that it is not difficult to remove the power cord from the outlet.



WARNING: Do not operate the equipment with a damaged power cord.



WARNING: Position the power cord so that it cannot be tripped over, walked on, rolled over, crimped, bent, pinched, or accidentally pulled from the wall outlet.



WARNING: Do not use the instrument near water and be careful not to spill liquids on any part of it.



WARNING: Do not operate the KXL System in the presence of flammable mixtures or anesthetics.



WARNING: Never look directly into the UV light beam. Never direct the beam towards a person except for therapeutic purposes.



WARNING: Ignoring local regulations on use of electro-optical medical devices may cause malfunction due to electromagnetic interference.



WARNING: The remote contains replaceable batteries; if system is not going to be used for an extended period of time remove the batteries.



WARNING: Use of not included accessories results in non-compliance of the device



WARNING: System may be interfered with by other equipment even if that equipment complies with CISPR Emissions requirements. See Table 5-1.



WARNING: Use of this equipment adjacent to or stacked with other equipment should be avoided because it could result in improper operation. If such use is necessary, this equipment and the other equipment should be observed to verify that they are operating normally.



WARNING: Portable RF communications equipment (including peripherals such as antenna cables and external antennas) should be used no closer than 30cm (12 inches) to any part of the Avedro KXL system (110-01019), including cables specified by the manufacturer. Otherwise, degradation of the performance of this equipment could result.



WARNING: System shall not be serviced or maintained while in use with a Patient.



WARNING: MR Unsafe - Keep away from magnetic resonance imaging equipment.



WARNING: Do not use a damaged or malfunctioning device. Use of such devices may harm the user and/or patient

1.7 Radiation Safety Warnings



WARNING: Use only laser grade instruments in order to prevent reflected UV radiation from smooth metallic surfaces.



WARNING: UV emitted from this product. Avoid eye and skin exposure to unshielded products. Never direct the beam towards a person except for therapeutic purposes.

1.8 Patient Safety

- The treatment should take place in a quiet and relaxed atmosphere in order not to distract the attention of the patient. The patient should lie on a table or patient's chair. The patient's head should rest comfortably in a headrest. It is imperative that the table or patient's chair or the system not be moved during the treatment procedure.



CAUTION: The KXL System is a medical device. It may be operated, therefore, only in health care facilities or medical areas under the supervision of medically trained personnel.

1.9 Additional Safety Considerations

- Any modification of the system's external light beam by means of optical elements is strictly prohibited.
- Plastic instrumentation such as speculums or eye shields may be damaged when impacted by the UV beam, possibly resulting in product degradation. Therefore, only Avedro recommended accessories or stainless-steel surgical instruments should be used.

- Smooth metallic surfaces can reflect despite the effort to blank them. Therefore, only laser grade instruments should be used.

1.10 FCC Compliance Notice

This equipment has been tested and found to comply with the limits for a Class B digital device, pursuant to Part 15 of the FCC Rules. These limits are designed to provide reasonable protection against harmful interference in a residential environment. This equipment generates, uses, and can radiate radio frequency energy and, if not installed and used in accordance with the instruction manual, may cause harmful interference to radio communications. However, there is no guarantee that interference will not occur in a particular installation. If this equipment does cause harmful interference to radio or television reception, which can be determined by turning the equipment off and on, the user is encouraged to try to correct the interference by one or more of the following measures:

- Reorient or relocate the receiving antenna.
- Increase the separation between the equipment and receiver.
- Connect the equipment into an electrical outlet on a circuit different from that to which the receiver is connected.
- Consult Avedro Customer Service for help.
- Properly shielded and grounded cables and connectors must be used in order to meet FCC emission limits. Proper cables and connectors are available from Avedro. Avedro is not responsible for any radio or television interference caused by unauthorized changes or modifications to this equipment. Unauthorized changes or modifications could void the user's authority to operate the equipment.

2 Introduction

2.1 System Overview

The KXL System is an electronic medical device which delivers ultraviolet light (365 nm wavelength) in a circular pattern onto the cornea after a solution of Riboflavin has been applied. Irradiating the Riboflavin creates singlet oxygen, which forms intermolecular bonds in corneal collagen, stiffening the cornea through cross-linking. UV flux and irradiation time (that is, fluence) at the cornea are controlled by an onboard computer system.

The *Optics Head* houses the UVA irradiation mechanism and camera. The LED is preset by the manufacturer to emit UVA radiation at a wavelength of 365 nm at an intensity of 3 mW/cm² to 45 mW/cm².

A fixed aperture mounted in the UVA irradiation beam path is used to produce a uniform circular area of irradiation at the treatment plane with an approximate diameter of 9 mm. Alignment lasers are used to aid the user in focusing the beam on the patient's cornea. Fine alignment of the UV beam through observation of the alignment lasers is controlled through a wireless remote and an internal drive system. Treatment power is selectable by the user from 3 mW/cm² to 45 mW/cm² in 1 mW/cm² increments. Total Energy is selectable in 0.1 J/cm² increments on the user interface. However, actual limits to power and energy are controlled by the RFID treatment card.

The KXL is a portable system with an articulating arm to allow movement of the system for alignment of the UV Beam to the patient's cornea. The treatment parameters (Riboflavin Induction Period, Total UV Energy, UV Power and UV Pulse Cycle Times) are selected through the user interface touch screen computer.

The KXL System is used in conjunction with a Riboflavin solution and an RFID card.

2.1.1 Major Components

The major components of the KXL System include the following:

- Optics Head with UV source and Camera
- KXL console with user interface
- Wireless remote control (with replaceable batteries)
- KXL Accelerated Crosslinking Treatment Kit (disposable supplied separately)
- Hospital Grade AC power cable (Lockable/detachable)
- System Part Number: 110-01019



Figure 2-1. Overview Illustration of System

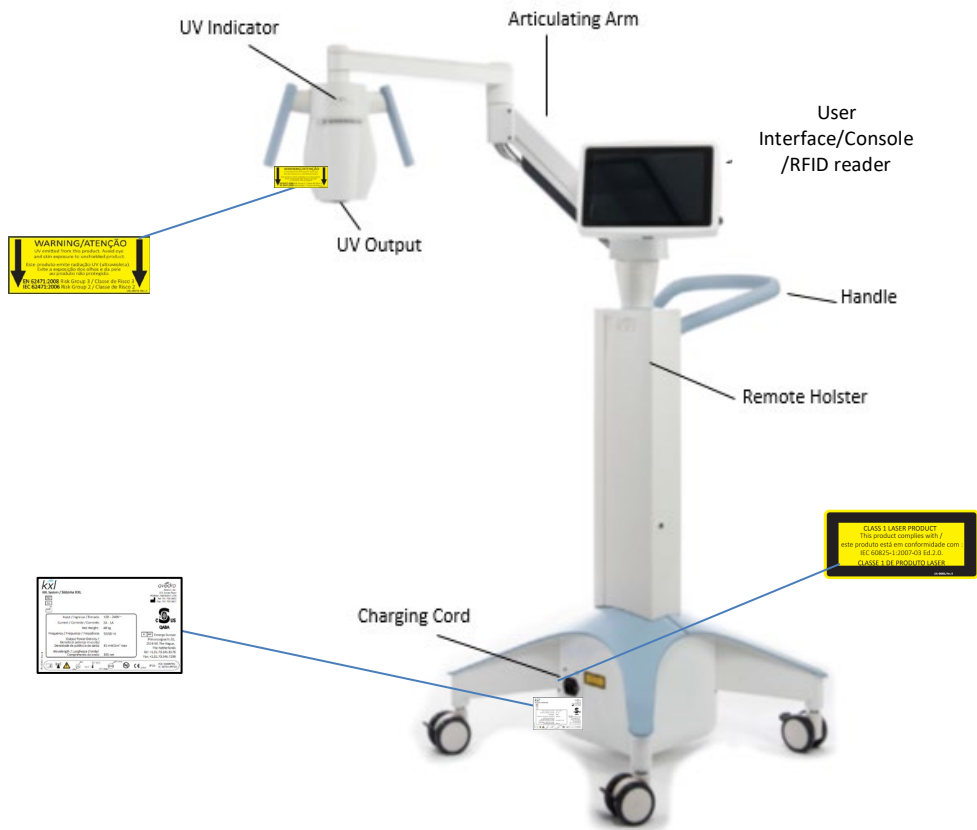
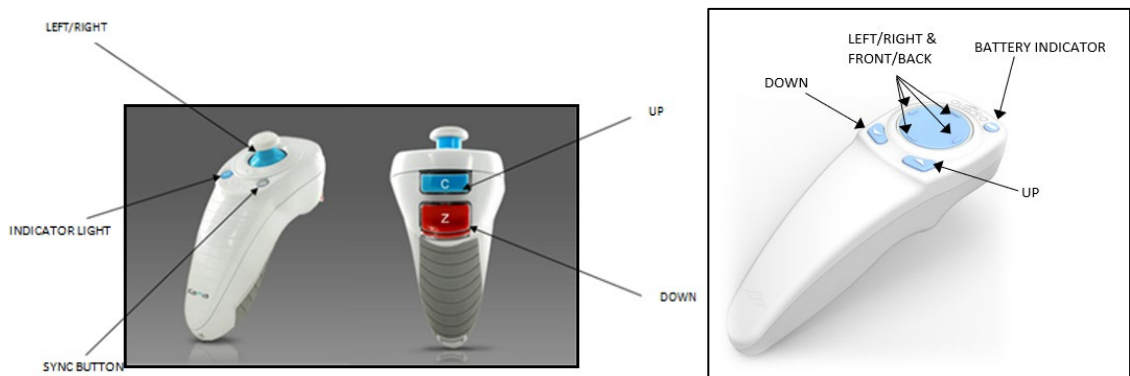

Figure 2-2. System Illustrations with Callouts



ORIGINAL REMOTE CONTROL or UPDATED REMOTE CONTROL

Figure 2-3. Wireless Remote

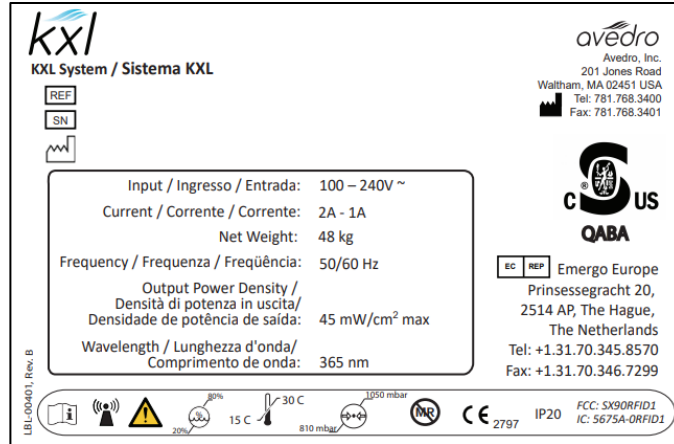

Figure 2-4. KXL Label



Figure 2-5. UV emitting Label



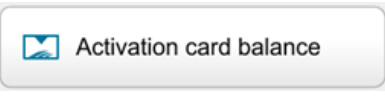
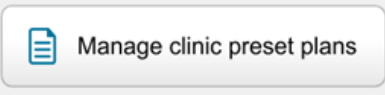
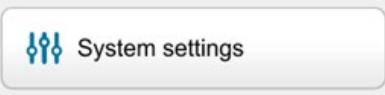
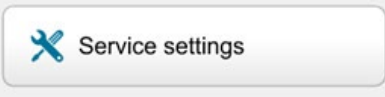
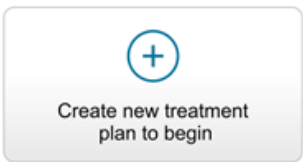







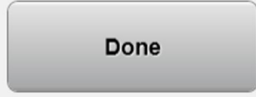







Figure 2-6. Laser Classification Label

3 System Operation

3.1 Touchpad/Keyboard Use

The table below identifies and describes important touchpad keys and icons unique to KXL System operation. Chapter 2 identifies and describes the KXL System’s major components.

Touchpad Key	Icon	Description/Function
Power Off button (Initial screen)		Turns OFF electric power to the console.
Add new patient button (Initial screen)		Add patient information prior to treating the patient
Options button (Initial screen)		Displays system settings and managing preset plans
Activation card balance button		Displays balance on treatment card
Manage clinic preset plans		Modify parameters of preset treatment plan
System Settings		Device settings menu is displayed
Service settings		Ability to edit default parameters
Create new treatment plan to begin (Patient overview screen)		Starts preset or modified treatment plan for patient
UP arrow (various Clinical Protocol screens)		Increases the value of the current field.
DOWN arrow (various Clinical Protocol screens)		Decreases the value of the current field.

Touchpad Key	Icon	Description/Function
X button (various screens)		Cancels all the entries on a screen and returns to the previous screen.
Checkmark button (various screens)		Directs the system to accept the current screen entries and to proceed to the next step.
Cancel button (various screens)		Cancels all the entries on a screen and returns to the previous screen.
Done button (various screens)		Registers any changes on a screen or provides user with notifications and then returns to previous screen.
Export button		Exports patient treatment report to USB
Add comment button (patient overview screen)		Add notes to a patient treatment report.
Trash Can icon		Delete photos taken during treatment.
Cancel Treatment button (various Clinical Protocol screens)		Cancels a treatment session for a patient.
Start timer button		Starts treatment timer
Change treatment type button		Changes treatment type
Perform treatment button (various Clinical Protocol screens)		Starts treatment



CAUTION: Only qualified and experienced personnel shall operate the KXL System.

3.2 UV Energy (Dose)

- The UV Energy (Dose) is the product of the UV Power (Intensity) and the UV Irradiation Time. The UV Energy and UV Power are adjustable and the calculated UV Irradiation Time is displayed.
- The System tracks UV Energy, UV Power, UV Irradiation Time and Total Treatment Time during the treatment.
- These options are selectable by the user during the treatment plan mode. See Section 3.8.3
- There are two UV treatment modes available, Continuous and Pulsed.

- Continuous Mode: UV output is constant for the duration of the UV treatment.

Continuous Mode Parameters:

Induction Period: 1 second - 30 minutes
 UV Energy*: 1 - 10.7 J/cm²
 UV Power: 3 - 45 mW/cm²

**The user may select UV Energy in 0.1 J/cm² increments. The energy range is controlled by the RFID card.*

- Pulsed Mode: UV output turns ON and OFF at user selected intervals.

Pulsed Mode Parameters:

Induction Period: 1 second - 30 minutes
 UV Energy*: 1 - 10.7 J/cm²
 UV Power: 6 - 45 mW/cm²
 UV ON Time: 1.0 - 4.0 Seconds
 UV OFF Time: 1.0 - 4.0 Seconds

**The user may select UV Energy in 0.1 J/cm² increments. The energy range is controlled by the RFID card.*

- Please reference Riboflavin Instructions for Use (IFU) for formulation information.

3.3 Preparing the System

- Position the KXL System adjacent to the treatment table or chair. Lock the casters to secure the device's position.
- Make sure the System is turned ON.
- When System is in use, keep head away from bright lights, such as positioning in front of windows.
- Check glass window of beam aperture for dust and dirt. See Sections 4.7 and 4.8 for cleaning instructions.

3.4 Important Steps before Turning On the System

- The user is responsible for assuring that the KXL System is functioning properly before starting a treatment.
- To ensure the System is functioning properly, consider the following mandatory points:
 - Inspect the device, accessories, and connecting cables for visible damage.
 - Take local regulations for use of portable electro-optical medical devices into consideration.

3.5 Powering Up the System

- Turn ON the master power switch on the base of the KXL System, adjacent to the power cord plug. This switch provides AC mains power to the KXL System.
- Press and release the power-on button on the side of the KXL display screen. See Figure 3-1. The KXL System will begin a power-up sequence, loading the operating system and all configuration and reference files.



Figure 3-1. Power Switch

- NOTE: If there is a Start-up error, please note any error messages and contact your distributor or Customer Service.
- Please see Section 3.21 for Power Down sequence instructions.
- The Patient List, shown in Figure 3.2, stores:
 - Previously treated patients
 - Untreated patients with saved treatment plans
 - New patients with no assigned treatment plans

Last	First	Patient ID	Sex	DOB	Treatment status
Allen	April	23434221	F	28 Feb, 1967	Created OS LASIK/PRK - 9 Feb
Anderson	James	65334533	M	19 Jul, 1982	Created OD Accel CXL - 10 Feb
Birmingham	Gerard	34234244	M	1 Jan, 1973	Treated OD, OS Multiple - 9 Feb
Bradford	Rachel	12323197	F	18 Oct, 1969	Treated OD OS Custom - 2 Feb
Chamford	Steven	58345999	M	13 Mar, 1984	Patient added 12 Feb
Costantino	Caroline	62445789	F	3 Mar, 1993	Created OD Preset 1 - 11 Dec

Figure 3-2. Patient Database

3.6 Existing Patient Data

- To search Patient List for an existing patient, tap in the “search patients” box and a keyboard will generate. Type patients name in and results will populate.

3.7 Add New Patient

- To begin adding a new patient, select “Add new patient,” and the pop-up window shown in Figure 3-3 will appear.

The screenshot shows a form titled "Add New Patient" with the following fields and values:

- Last name: Thomas
- First name: Benjamin
- ID number: 338271
- Sex: Male (selected)
- DOB: 18 / January / 1985

Buttons at the bottom: Cancel, Use anonymous patient, and OK (highlighted with a yellow circle).

Figure 3-3. Enter Patient Information

- If “Use anonymous patient” is selected, last name field will populate as anonymous and an incrementing number will populate in “first name” field.
- Once the patient information is completed, the “OK” button will become available.
- Patients can be added at any time and are saved in the database once “OK” is pressed.

3.8 Create New Treatment Plan

- Select patient to treat from Patient Database
- Press “Create new treatment plan to begin”

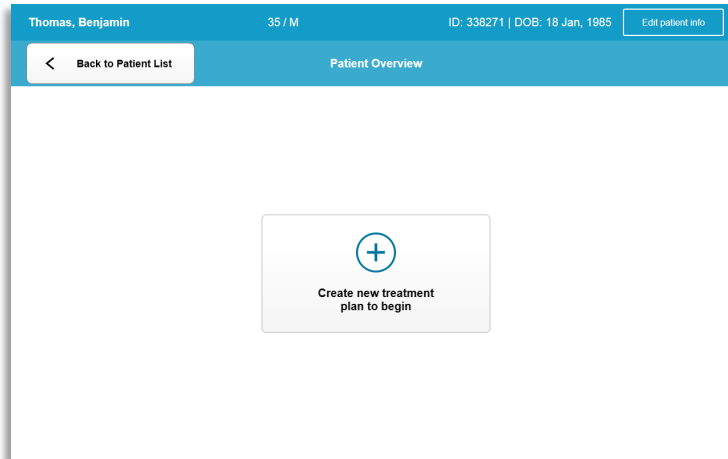

Figure 3-4. Create New Treatment Plan

3.8.1 Select Eye to Treat

- Choose the eye you wish to treat: OD or OS
- When eye is selected, the field will be outlined in blue as shown in Figure 3-5.

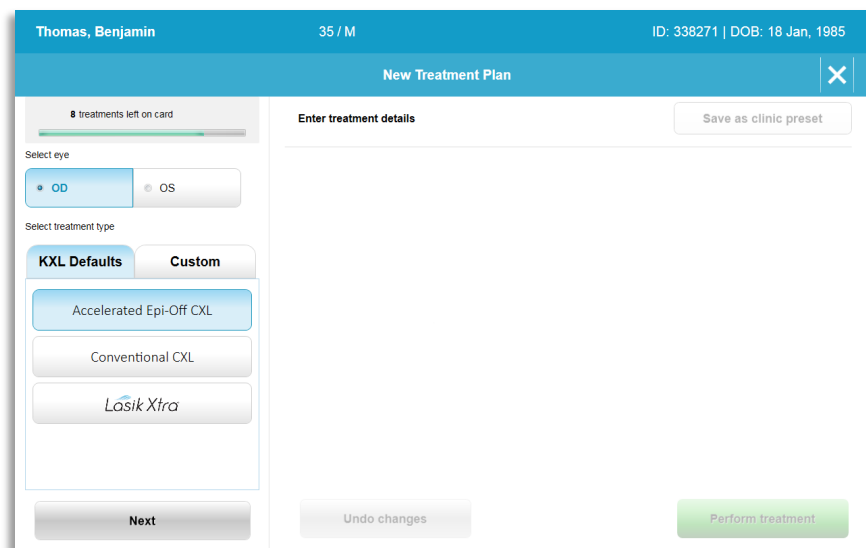

Figure 3-5. Select Eye

3.8.2 Selecting a KXL Default Treatment Type

- The System is pre-programmed with 3 KXL Default treatment plans as shown in Figure 3-5:
 - Accelerated Epi-Off CXL
 - Conventional CXL
 - LASIK Xtra
- Treatment parameters are preset for the KXL Default treatment plans.
- Select the desired KXL Default treatment plan and then select “Perform Treatment” to proceed as shown in Figure 3.6.

Thomas, Benjamin 35 / M ID: 338271 | DOB: 18 Jan, 1985

New Treatment Plan

8 treatments left on card

Select eye

OD OS

Select treatment type

KXL Defaults Custom

Accelerated Epi-Off CXL

Conventional CXL

Lasik Xtra

Change treatment type

OD - Accelerated Epi-Off CXL Save as clinic preset

Formulation: VibeX Rapid

Riboflavin induction time: 10 min 0 sec

UV irradiance: 30 mW/cm²

Total UV dose: 7.2 J/cm²

UV delivery: Pulsed

Pulse duration: On 1.0 sec Off 1.0 sec

Total treatment time: 8 min 0 sec

Undo changes Perform treatment

Figure 3-6. Perform a Default Treatment Plan

3.8.3 Custom Treatment Plans

- Any of the KXL Default plans can be edited to change energy dose, irradiance or other treatment dose parameters then saved for future use as a “Custom” treatment plan.
- Select the KXL Default as a starting point or select the “Custom” treatment type tab to create a new, custom plan.
 - If KXL Default was selected, press “Save as clinic preset” to save to the “Custom” treatment type tab.
 - Input a name for the clinic preset treatment plan.

Figure 3-7. Save Clinic Preset Treatment Plan

- Select “OK” then select the new clinic preset treatment plan from the “Custom” treatment type tab
- Individual parameters may be edited in Custom treatment plans.
- Press within the specific parameter and use the arrows to increase or decrease the desired field.
- Select “Save changes” if it is desired to use the same custom treatment plan in the future.

3.8.4 Modifying Custom Treatment Parameters

- There are two UV treatment modes available, Continuous or Pulsed.
Continuous Mode: The UV output is constant for the duration of the UV treatment.
- Pulsed Mode: The UV output turns ON and OFF at user selected intervals.
- In the example below, the user selects “Continuous” UV treatment mode by pressing the dropdown menu to the right of “UV Delivery” as shown in Figure 3-8.

The screenshot shows a user interface for creating a new treatment plan. At the top, the patient's name 'Thomas, Benjamin', age '35 / M', and ID 'ID: 338271 | DOB: 18 Jan, 1985' are displayed. The main title is 'New Treatment Plan'. On the left, there is a progress bar for '8 treatments left on card' and options to 'Select eye' (OD or OS) and 'Select treatment type' (KXL Defaults or Custom). Under 'Custom', there are two options: 'CXL Treatment Custom' and 'my treatment'. The main area shows parameters for 'OD - my treatment': Formulation (VibeX Rapid), Riboflavin induction time (10 min 0 sec), UV irradiance (30 mW/cm²), Total UV dose (7.2 J/cm²), UV delivery (Continuous), and Total treatment time (4 min 0 sec). Buttons for 'Save changes', 'Undo changes', and 'Perform treatment' are at the bottom.

Figure 3-8. Custom Treatment Plan – Continuous UV Mode

- Enter the other desired Custom treatment parameters:
 - Total UV dose*
 - UV irradiance (3 – 45 mW/cm²)

NOTE: Total treatment time is automatically calculated and displayed.

* The user may select UV dose in 0.1 J/cm² increments. The dose range is controlled by the RFID card.

- Review and confirm all treatment parameters by selecting “Perform treatment”.

3.9 Starting a Treatment

- Choose patient from patient database.
- If a treatment plan was just created, select “Perform treatment”.

3.9.1 Insert Treatment / RFID Activation Card

- Insert the activation card all the way into the RFID slot and leave in place.



Figure 3-9. Insert KXL Activation Card

3.9.2 Single-use Activation Cards

- Keep card in place until read is complete.



Figure 3-10. Reading Activation Card

- The user will be alerted that only 1 treatment remains on the card as shown in Figure 3-11.



Figure 3-11. Card Treatment Balance

- The “OK” button will illuminate when the card has been read and treatment credit has been accepted by the System. The user may remove the card at this time if desired.

3.9.3 Multi-use Activation Cards

- Once a multi-use activation card has been inserted, the display will show the number of treatments remaining on the card.
- Activation card can either be removed or remain in the RFID slot and stored for next use.

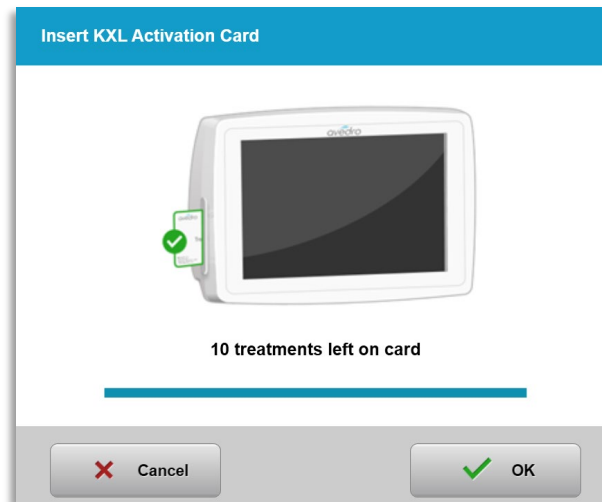

Figure 3-12. Card Balance: Treatments Remaining

- If treatment card only has one treatment left, the system will inform user to “Upgradecard before next treatment” as shown in Figure 3-11.
- If no treatments remain on the card, the system alerts the user to insert a different card as shown in Figure 3-15.

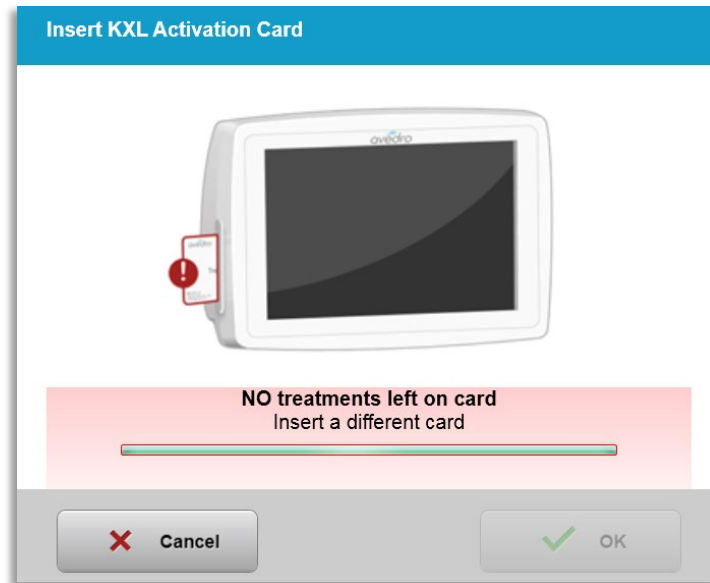

Figure 3-13. No Treatments Left

3.9.4 RFID Card-controlled Limits

- o If the user has programmed a UV dose range that is outside the allowable value(s) controlled by the RFID card, an "Invalid treatment parameters" message will appear after "Perform treatment" has been selected.

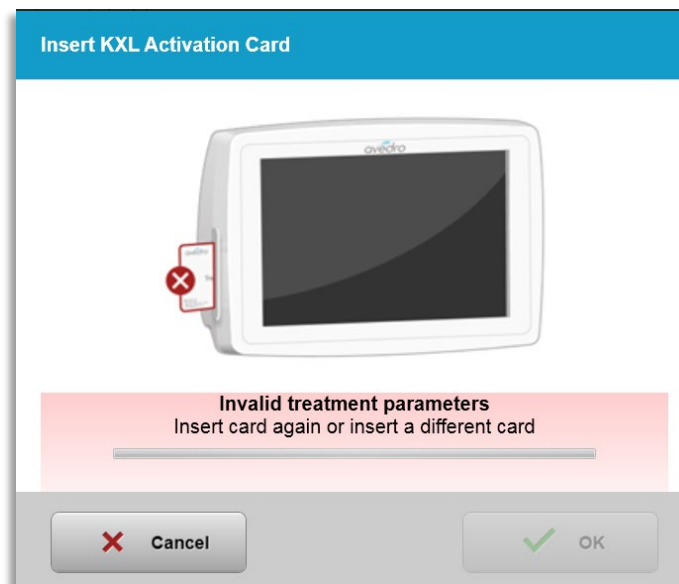

Figure 3-14. Invalid Treatment Parameters

- o Go Back to Treatment Parameters to enter appropriate parameters.
- o If the user has the treatment card inserted while programming treatment parameters that are outside the allowable value(s) controlled by the RFID card, the following message will appear and "Perform treatment" will unable to be selected as shown in Figure 3-16.

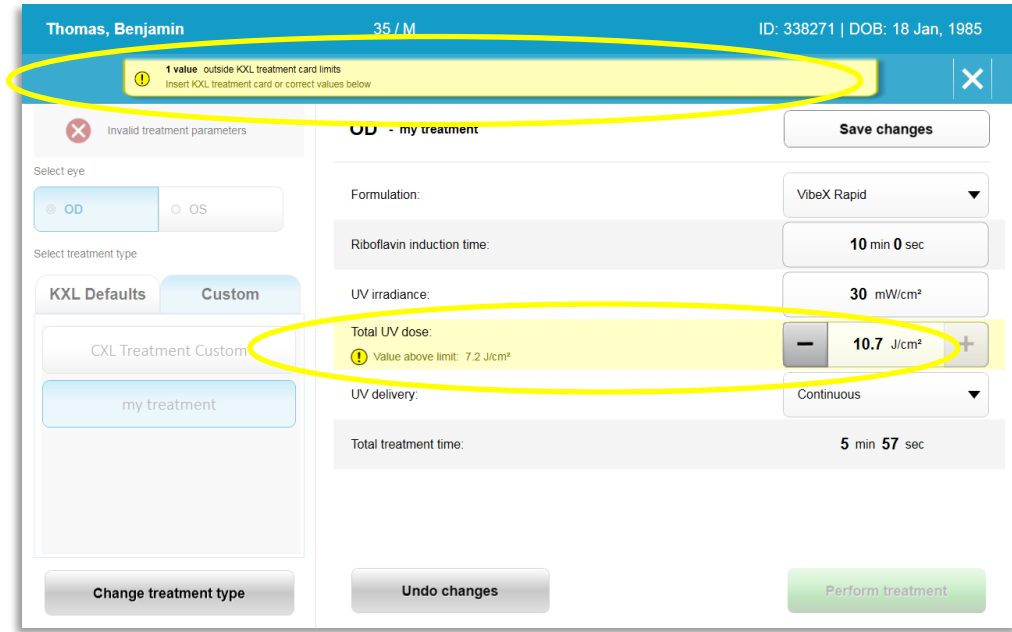

Figure 3-15. Invalid Treatment Parameters

3.9.5 Sync Alignment Remote

- o The Sync alignment remote message will be visible on the screen for 15 seconds as shown in Figure 3-16.

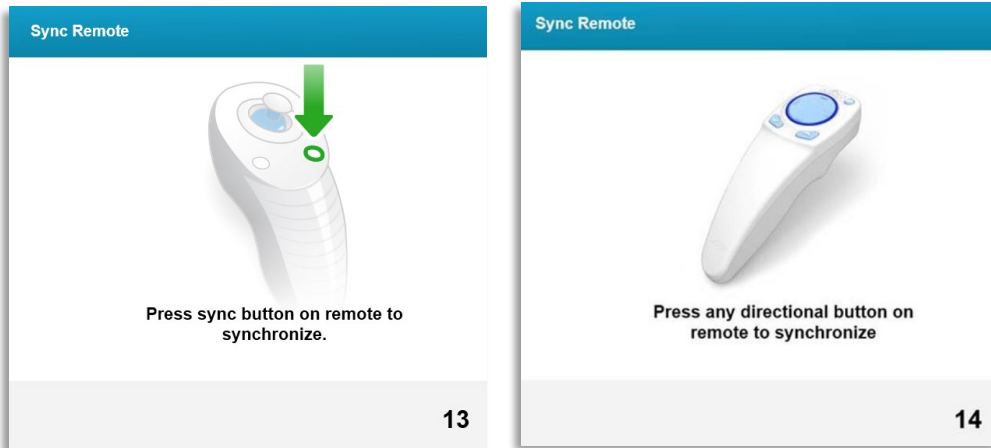

Figure 3-16. Sync Remote

- o If using the Updated Remote (see Figure 2.3), press any directional button to synchronize the remote within the 15-second timeframe. This is required for every procedure if use of the remote is desired.
- o If using the Original Remote (see Figure 2.3), press the sync button denoted with an “S” on the remote to synchronize the remote within the 15-second timeframe. See Figure 3-17 for sync button location. This is required for every procedure if use of the remote is desired.

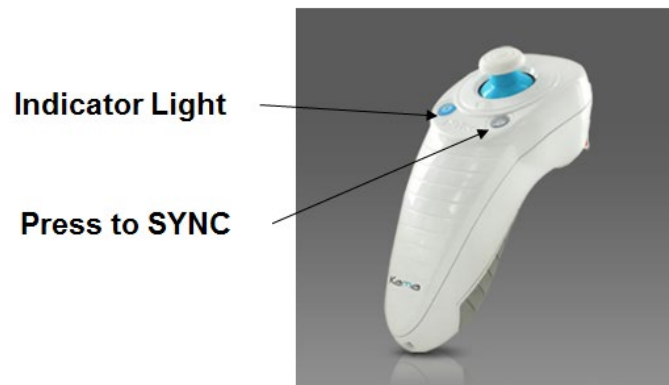

Figure 3-17. System Setup Status

- o The system will beep every 2 seconds during the 15 second sync timeframe.
- o If the sync button is not pressed within the 15 second timeframe, a message stating “Sync Alignment Remote” will appear onscreen as shown in Figure 3-18.
- o Press “OK” to attempt to re-sync the remote, or choose to Cancel Treatment.

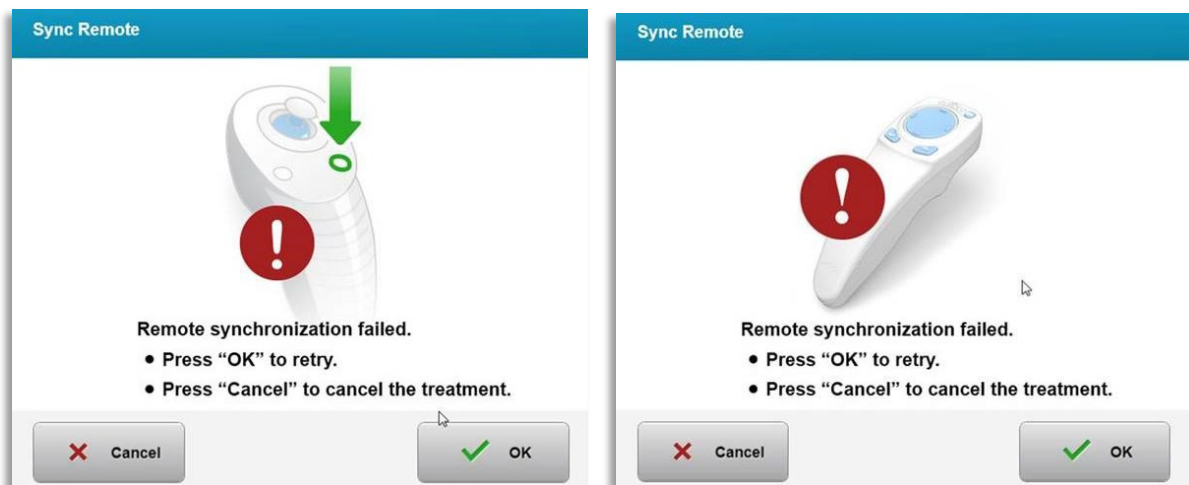

Figure 3-18. Sync Process Timed Out

- o The various statuses of the Original Remote Indicator Light are shown in Figure 3-19.
 - A constantly illuminated remote Indicator Light means that the remote is synchronized with the KXL.
 - If the Indicator Light is blinking constantly, replace batteries in the remote immediately to ensure proper operation.

Indicator Light Status	Meaning
ON	Actively Synchronized with the device
Blinking once per second for 10 seconds	Disconnecting Sync (After procedure)
Blinking constantly, twice per second	Replace batteries immediately (2 AAA)

Figure 3-19. Remote Indicator Light Status and Meaning

- o The various statuses of the Updated Remote Thumbpad Indicator Light and Battery Indicator Light are shown in Figure 3-20.

Thumbpad Indicator Light Status	Meaning
No illumination	Off
Revolving blue light	Synchronizing
Steady blue light	Synchronized and Ready
Steady orange light	Lost synchronization
Battery Indicator Light Status	Meaning
No illumination	Off
Steady blue light	Battery is OK
Steady orange light	Battery needs replacing
Flashing orange light	Battery must be replaced

Figure 3-20. Remote Indicator Light Status and Meaning

NOTE: The KXL system performs an internal self-test prior to each treatment to verify proper UVA calibration. The internal self-test uses a redundant set of optical sensors to ensure that accurate levels of UVA will be delivered for each treatment. If the internal self-test fails, an error message will be generated and the treatment cannot proceed. If this occurs, contact your distributor or Customer Service immediately.

3.10 Preparing the Patient

- Ensure that the patient is lying flat or reclined on a patient table or chair. His or her head should rest on a headrest.
- Adjust the table or chair and headrest so that the patient can rest comfortably for the duration of the treatment without head movement.
- Apply a lid speculum and optional drapes using standard clinical technique. NOTE: Onscreen eye images do not depict the lid speculum.

3.10.1 Applying Riboflavin, Induction, and Alignment

- Apply Riboflavin to the treatment eye in accordance with the Riboflavin Instructions for Use (IFU) and press “Start Timer.”

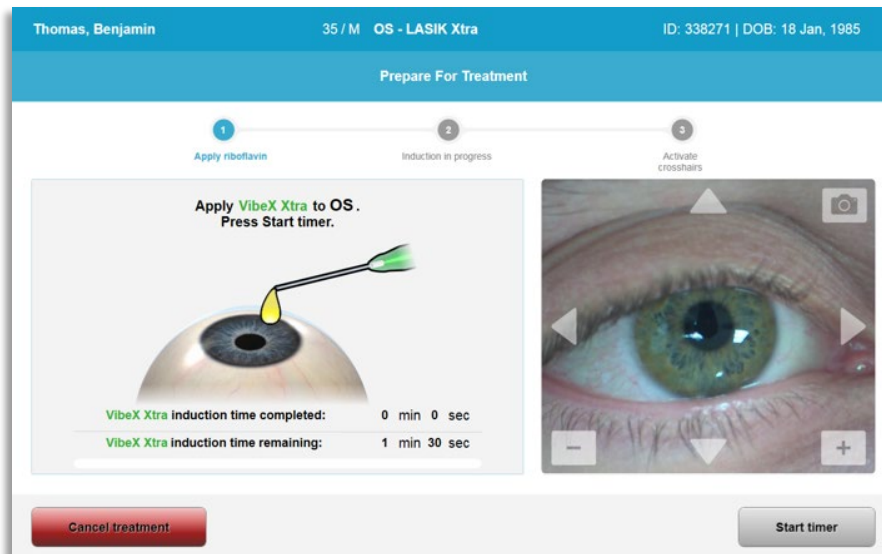

Figure 3-21. Prepare For Treatment: Apply riboflavin



CAUTION: Riboflavin is not a part of the KXL System described in this manual. For details, please refer to the Riboflavin’s Instructions for Use.

- Red alignment lasers will turn on 30 seconds before the end of the Induction period as shown in Figure 3-22.

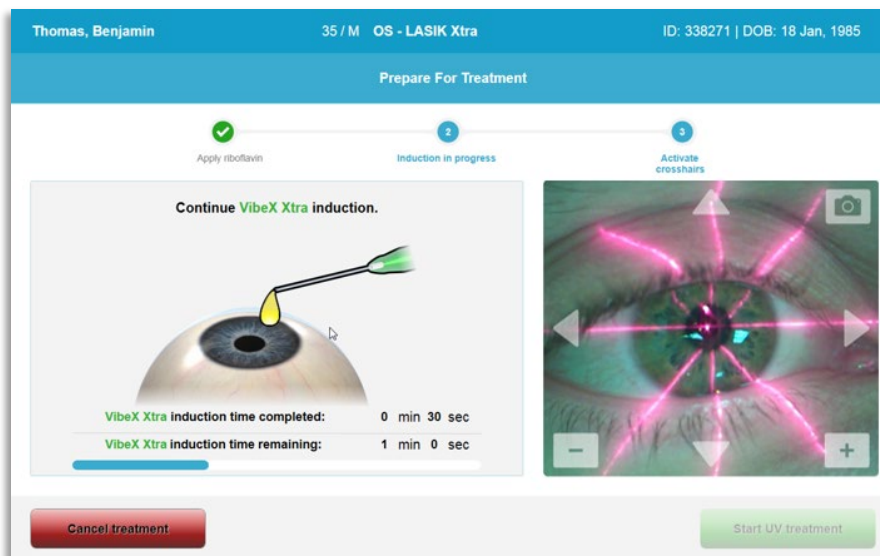

Figure 3-22. Align Crosshairs During Induction

- KXL has two alignment lasers as shown in Figure 3-23.
 - Red crosshair for X and Y axis positioning.
 - A second red crosshair for Z axis positioning.

- o **NOTE:** Crosshairs may differ in appearance. They may appear thicker, thinner, longer or shorter.

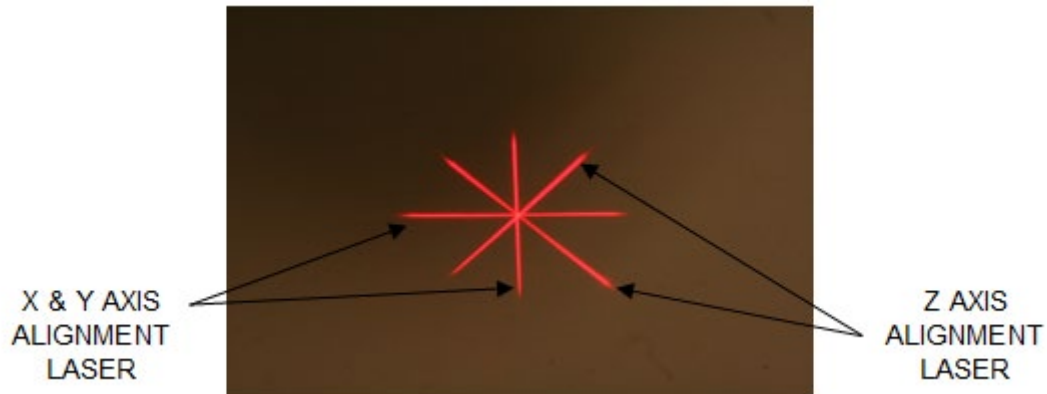
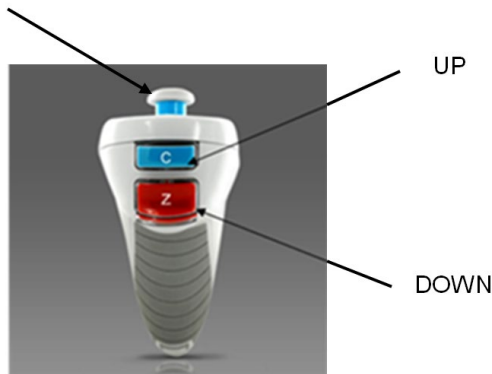

Figure 3-23. Alignment of Red Crosshairs - X & Y Axes and Z Axis

- o When alignment lasers turn on, align the crosshairs over the eye to be treated.
 - Manually move the KXL head back and forth and left and right until the X/Y axes' red crosshairs are aligned to the center of the pupil.
 - Manually move the KXL head up and down to align the Z axis second red crosshair to the center of the first red crosshair.
 - Fine tune the alignment as needed using the wireless remote or by pressing the onscreen arrows.
- o **NOTE:** For correct alignment when using the remote, the Avedro logo on KXL head should face the user. Figure 3-24 displays the remote functions to use during the alignment process.

LEFT / RIGHT



ORIGINAL REMOTE

or

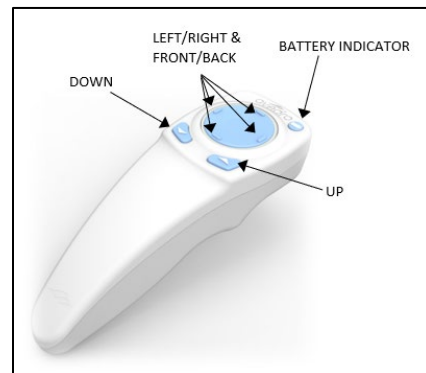

UPDATED REMOTE

Figure 3-24. Remote Functions

3.11 Initiating Treatment

- Once the Riboflavin application, Induction, and Alignment of Crosshairs are complete, initiate treatment by pressing the “Start UV treatment” button as shown in Figure 3-25.

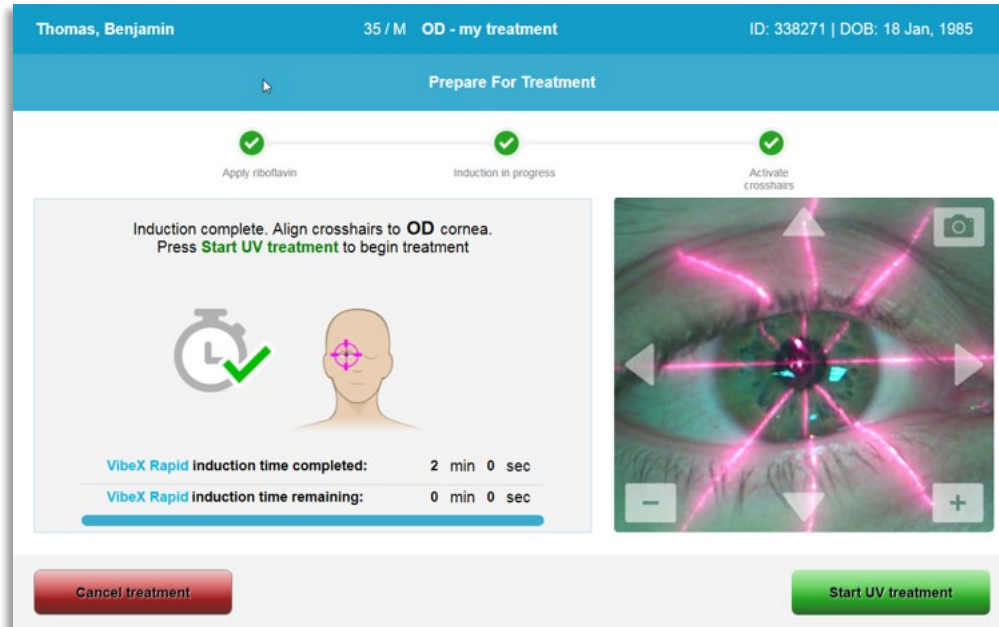

Figure 3-25. Start UV Treatment

- The patient should fixate on the red X & Y alignment crosshair throughout the treatment.
- Patients should remain still during the treatment.



WARNING: Start treatments only after the photosensitizer is applied.



CAUTION: UV light is emitted when the Avedro logo on the optical head flashes color from blue to green.



WARNING: Make sure that the KXL System and the patient’s table or chair are secured and not moved after alignment and during treatment.

3.12 Monitoring Treatment

- Check continuously that the area of interest on the cornea is illuminated with the UVA light and adjust as necessary using the wireless remote or the onscreen arrows.

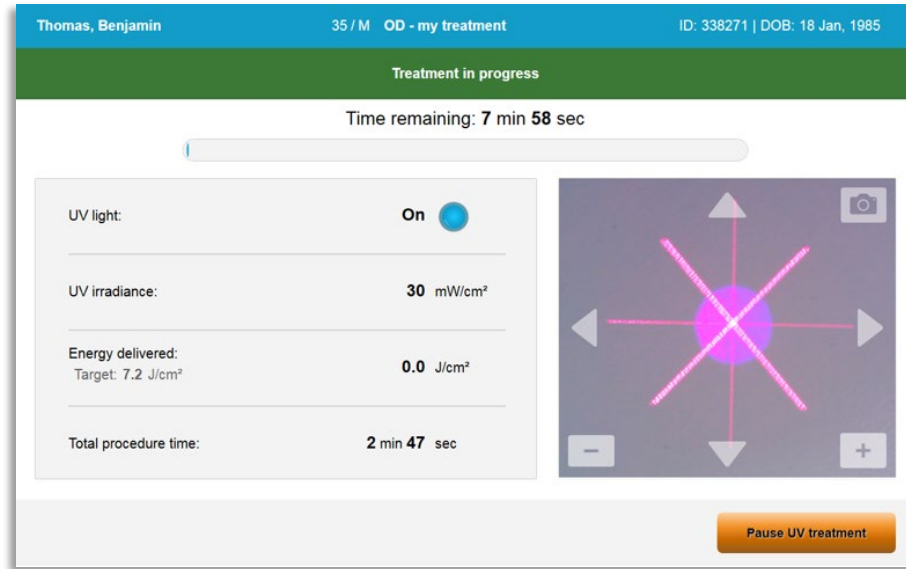

Figure 3-26. Treatment in Progress Screen

- **NOTE:** When using Pulsed Treatment mode, UVA light will not be visible during the OFF periods. The User Interface will not change to “UV is OFF” during these cycles.

3.13 Pausing a Treatment

- The treatment stops automatically after the user-programmed timer expires.
- The user may decide to stop or interrupt the treatment. In such case, the UV light can be switched OFF by pushing the “Pause UV treatment” button.

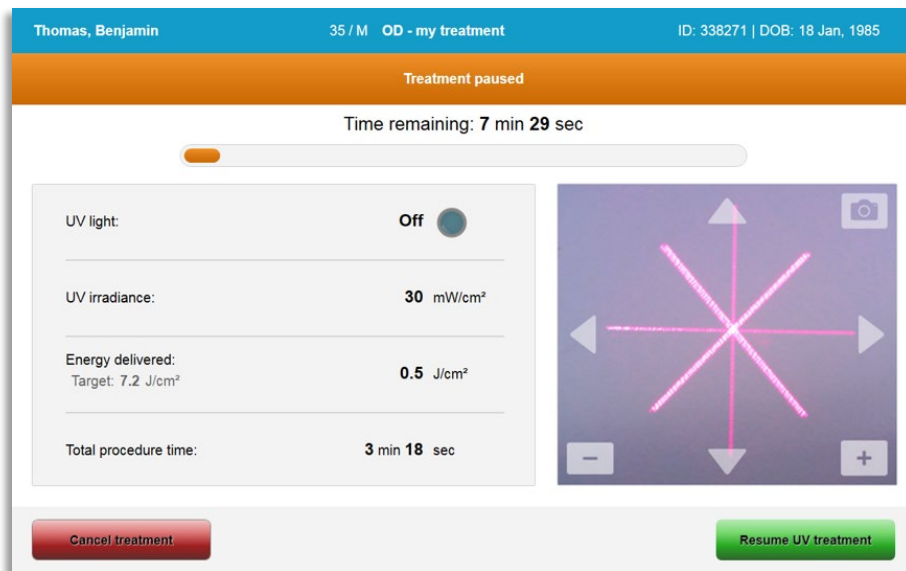

Figure 3-27. Treatment Paused Screen

- To cancel or resume treatment select “Cancel treatment” or “Resume UV treatment” respectively. See Section 3.14 if cancelling a session.

3.14 Cancelling Mid-Treatment

- A warning pop-up will appear when “Cancel treatment” is selected mid-treatment as shown in Figure 3-28.
- To confirm treatment cancellation, select “Yes”.



Figure 3-28. Confirm Cancel Partial Treatment

- If treatment cancellation was confirmed, an onscreen “Treatment Cancelled” message will appear as shown in Figure 3-29.

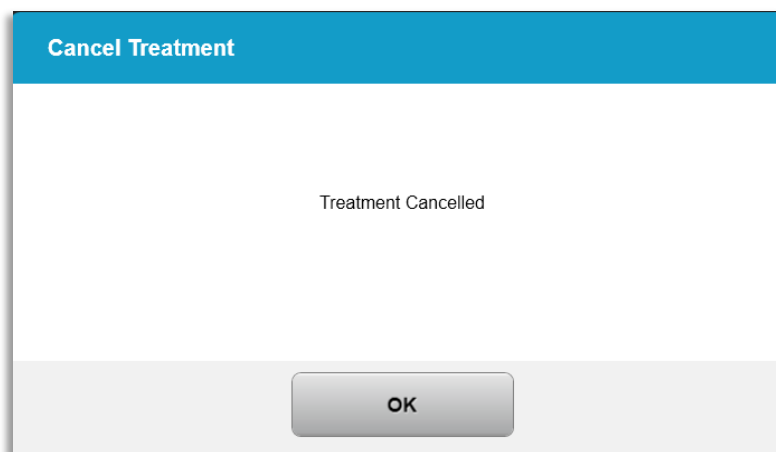

Figure 3-29. Treatment Cancelled Confirmation

- Select “OK” on the Cancel Treatment confirmation screen.
- Partial Treatment information will be displayed as shown in Figure 3-30.

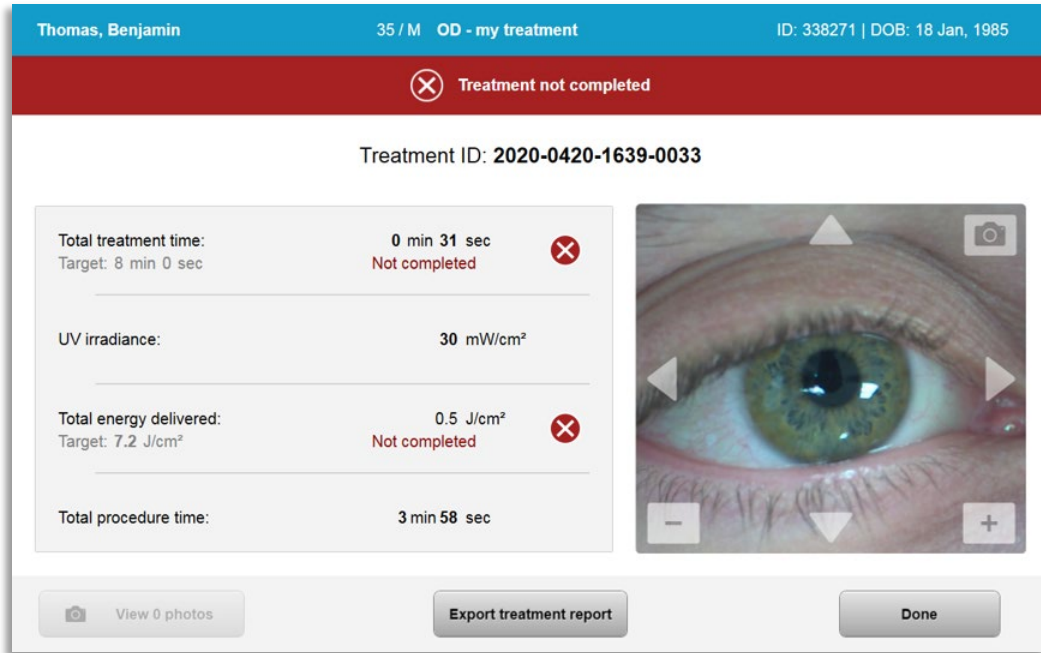

Figure 3-30. Partial Treatment Not Completed

3.15 Capturing Images

- Images can be taken at any stage throughout the treatment process.
- To capture an image, select the camera button in the top right hand corner of the eye image as shown in Figure 3-31.
- The image is automatically saved and available for review post-treatment.

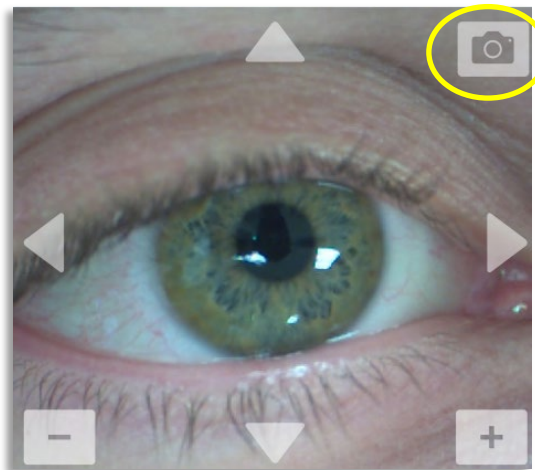

Figure 3-31. Capturing Images

3.16 Treatment Complete

- At the completion of a treatment, a summary of treatment parameters will be displayed, and the screen will show “Treatment complete” as shown in Figure 3-32.

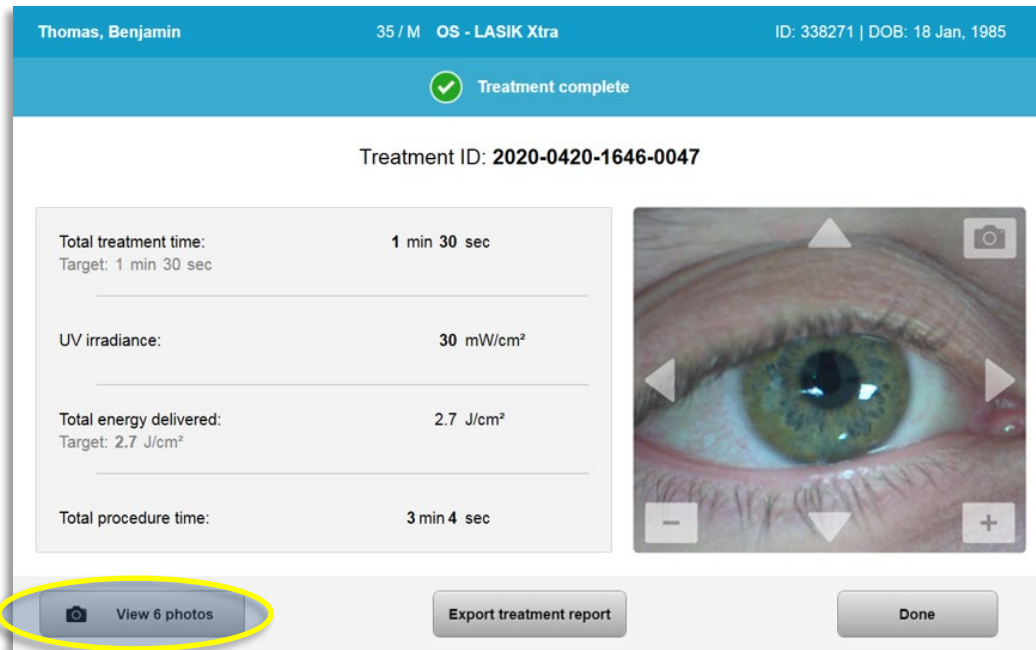

Figure 3-32. Treatment Complete Screen

- Carefully remove the device from the patient area.
- Follow up with normal post-op care.
- Remove speculum.

3.17 Reviewing Images

- All images taken throughout treatment are available for review post treatment.
 - Select “View Photos” to enter the photo gallery as shown in Figure 3-32.

3.18 Deleting Photos

- Photos taken throughout treatment can be deleted.
- In the Photo Gallery, select the trash icon next to the photo to be deleted as shown in Figure 3-33.

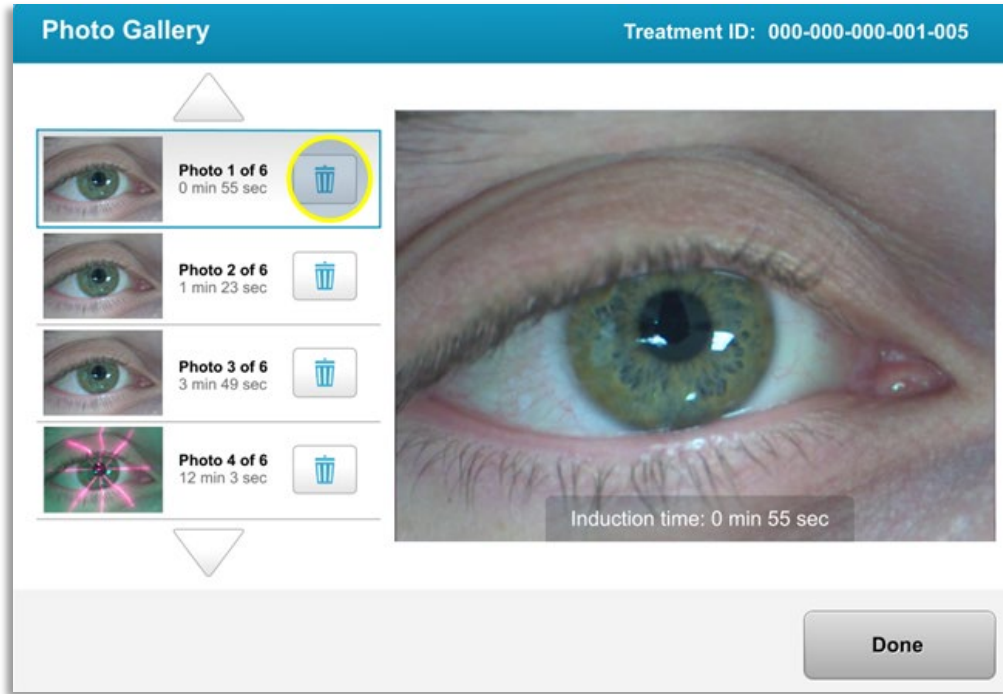

Figure 3-33. Select Trash to delete

- Once a photo is selected for deletion, select “Yes” to delete the photo, or select “No” to keep the image.

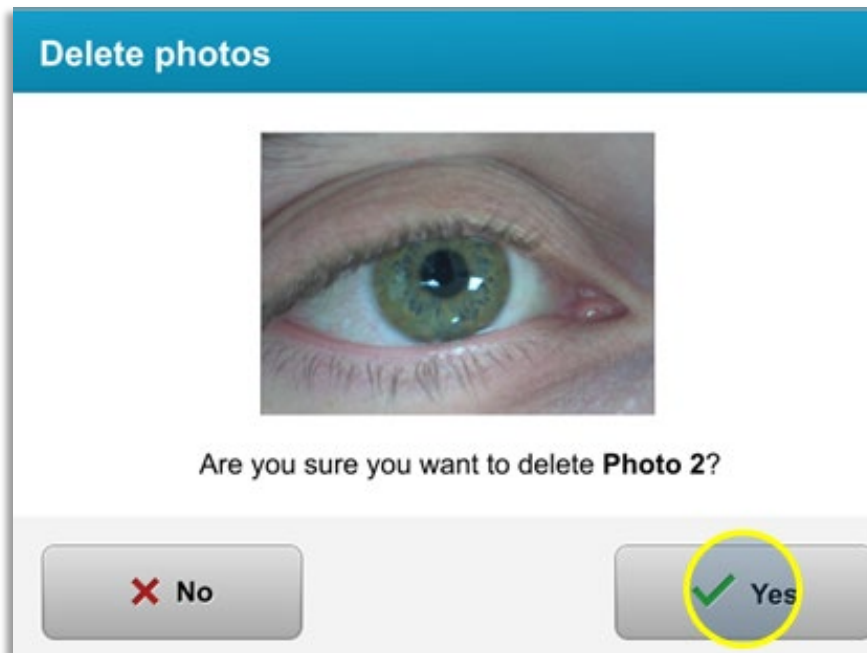

Figure 3-34. Select Yes to Delete

- Once deletion is confirmed, photo will not be retrievable.

- Select “Done” to confirm which photos will be displayed in the treatment report.

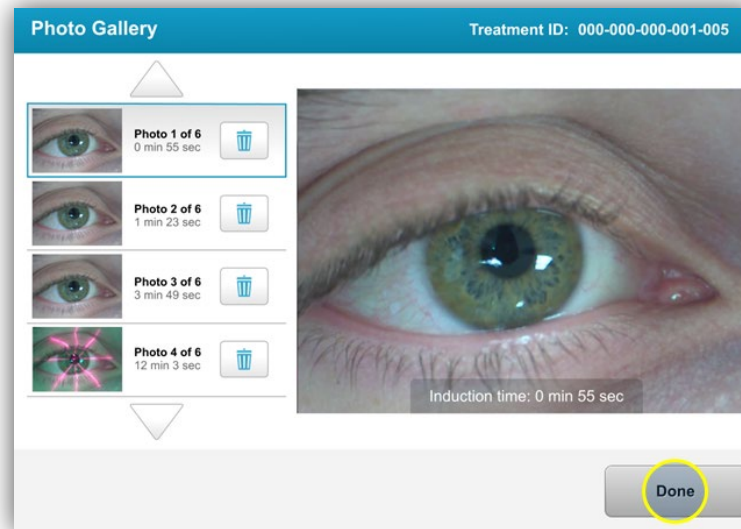

Figure 3-35. Select Done

3.19 Patient Treatment Report

- A treatment report is generated containing patient information, treatment details, photos taken throughout treatment, and notes. A sample report is shown in Figure 3-36.
- Treatment reports are generated even if treatments are paused or cancelled.
- A green checkmark will be listed next to completed phases.
- A red “X” mark will be listed next to incomplete phases.

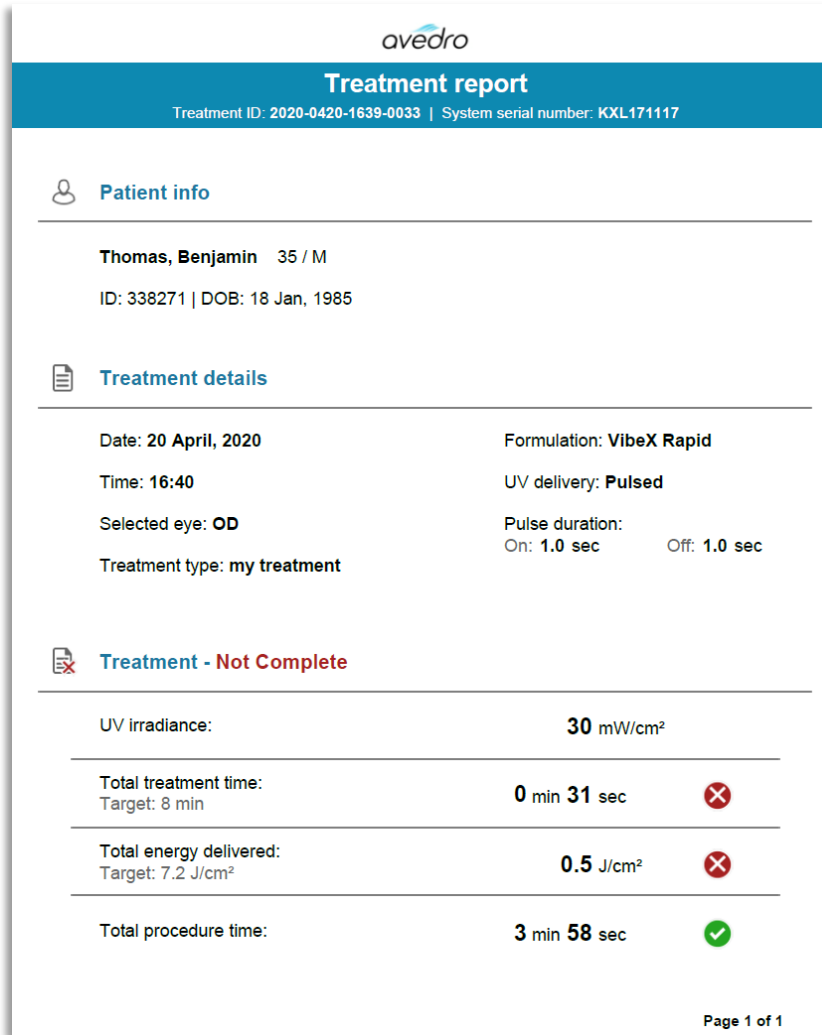

Figure 3-36. Sample Treatment Report

3.19.1 Adding Notes to a Patient Treatment Report

- o From the Patient Database screen, select the patient's name.
- o Press the message icon as shown in Figure 3-37 to enter comments about the patient's treatment.
- o Keyboard will become available to make comments to the patient's report. Figure 3-38 depicts comments in a Patient Report.

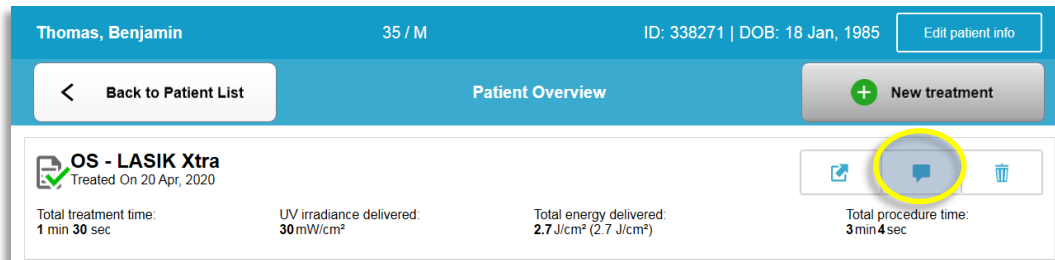

Figure 3-37. Comments Icon



Figure 3-38. Comments Section

3.19.2 Exporting Treatment Report

- o Select “Export treatment report” as shown in Figure 3-39 to save report to a USB stick.
- o Report will be exported as PDF.

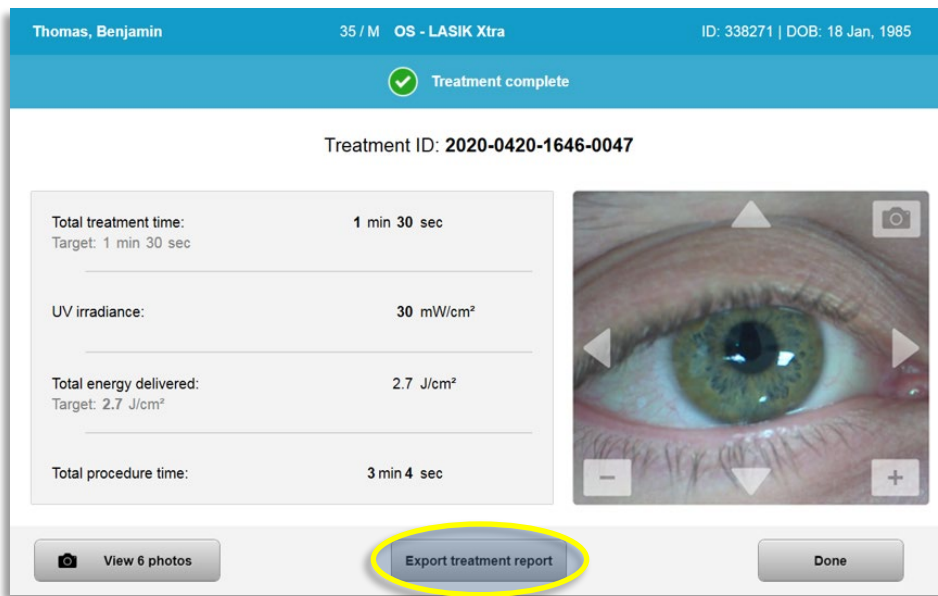

Figure 3-39. Exporting Treatment Report

- o The screen will prompt to insert USB drive as shown in Figure 3-40.
NOTE: Avedro does not supply USB drive for storing patient data.



Figure 3-40. Insert USB

- o If the USB is full or the system is unable to read the USB, an error message will be displayed as shown in Figure 3-41.

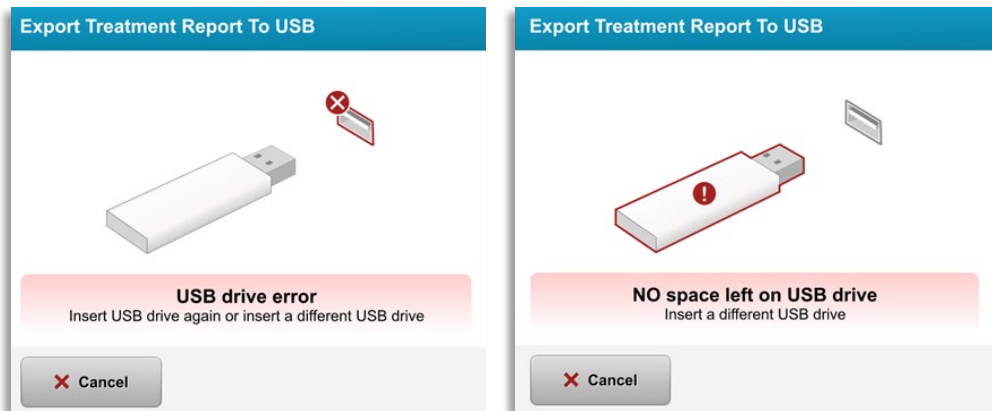

Figure 3-41. USB Error and No Space Left on USB

- o If there is no issue with the USB, a message will appear stating "Generating treatment report."



Figure 3-42. Generating treatment report

- o When the treatment report is exported, a confirmation message will appear as shown in Figure 3-43.



Figure 3-43. Treatment report exported

3.19.3 Viewing a Treatment Report

- Full treatment report can be reviewed on system or USB (if exported).
- Any photos or comments added will be included in report.



Treatment report

Treatment ID: 2020-0420-1646-0047 | System serial number: KXL171117



Patient info

Thomas, Benjamin 35 / M
 ID: 338271 | DOB: 18 Jan, 1985





Treatment details

Date: 20 April, 2020	Formulation: VibeX Xtra
Time: 16:47	UV delivery: Continuous
Selected eye: OS	
Treatment type: LASIK Xtra	



Treatment - Complete

UV irradiance:	30 mW/cm ²	
Total treatment time: Target: 1 min 30 sec	1 min 30 sec	
Total energy delivered: Target: 2.7 J/cm ²	2.7 J/cm ²	
Total procedure time:	3 min 4 sec	

Page 1 of 3

Figure 3-44. Page 1 of 3: Treatment Details

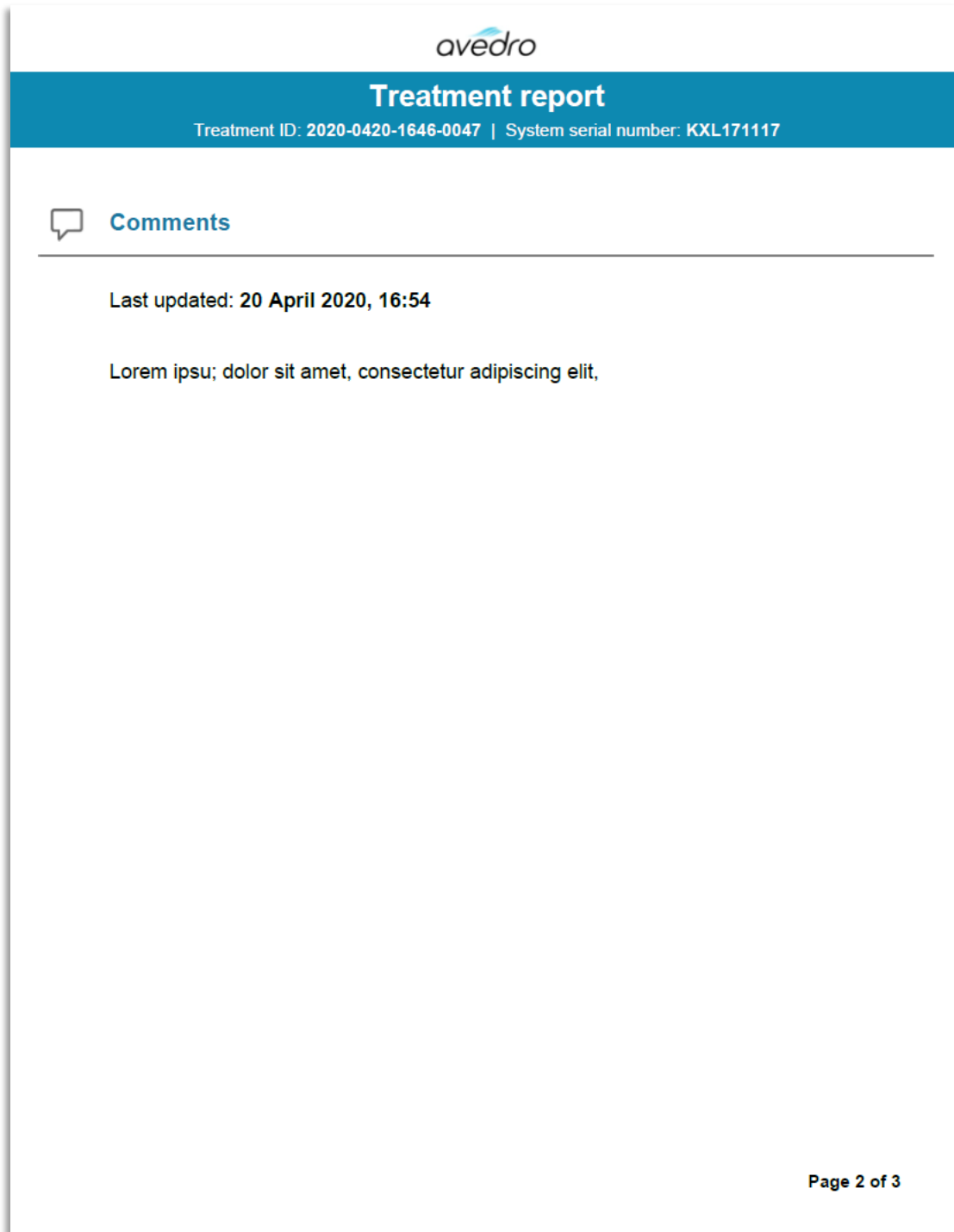







The screenshot displays the Avedro interface for a treatment report. At the top, the Avedro logo is centered. Below it, a blue header bar contains the text "Treatment report" in white, with "Treatment ID: 2020-0420-1646-0047 | System serial number: KXL171117" in smaller white text underneath. The main content area is white and features a "Comments" section. This section is introduced by a speech bubble icon and the word "Comments" in blue. A horizontal line separates this header from the content below. The content includes a timestamp "Last updated: 20 April 2020, 16:54" and a line of placeholder text "Lorem ipsu; dolor sit amet, consectetur adipiscing elit,". In the bottom right corner of the page, the text "Page 2 of 3" is displayed.

Figure 3-45. Page 2 of 3: Comments

avedro

Treatment report
Treatment ID: 2020-0420-1646-0047 | System serial number: KXL171117

 **photos (6)**

		
Induction time: 0 min 56 sec	Induction time: 1 min 12 sec	Induction time: 1 min 23 sec
		
UV exposure time: 0 min 1 sec	UV exposure time: 0 min 9 sec	UV exposure time: 0 min 12 sec

Page 3 of 3

Figure 3-46. Page 3 of 3: Photos

3.20 Powering Down the KXL System

- Select “Power Off” on the Patient List homescreen as shown in Figure 3-47.

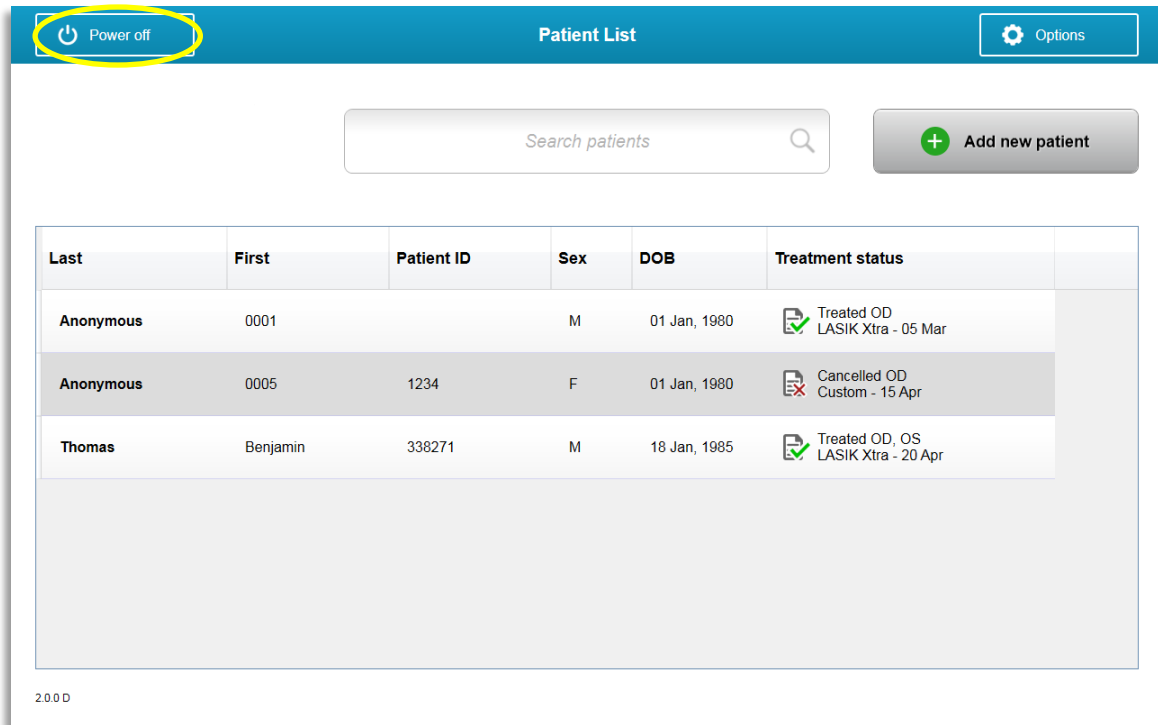

Figure 3-47. Select “Power Off”

- Confirm powering off system by selecting “Yes” as shown in Figure 3-48.

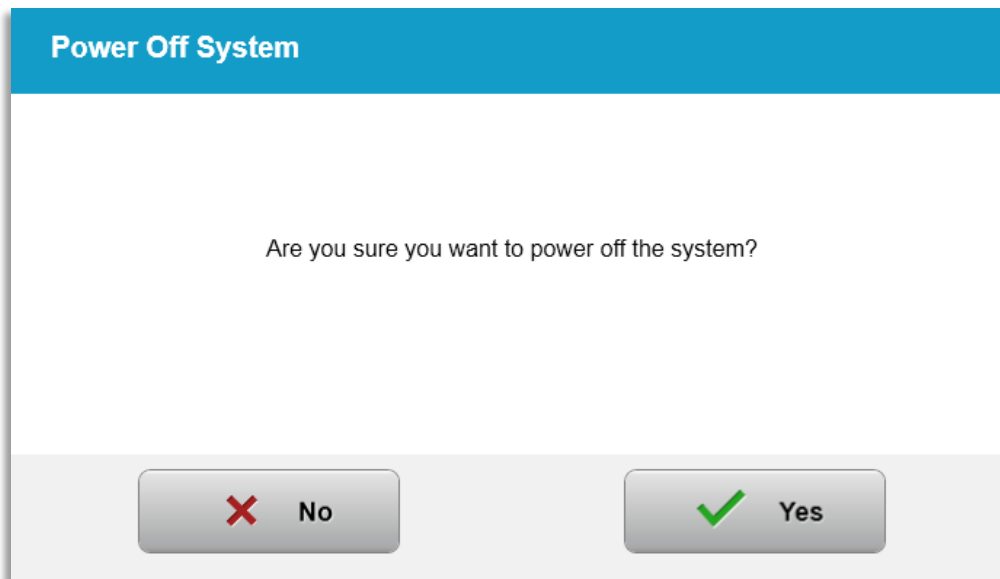

Figure 3-48. Confirm “Power Off”

- Wait for the software to shut down and the screen to go blank.

- Turn the master power switch on the KXL base to the “Off” position as shown in Figure 3-49.

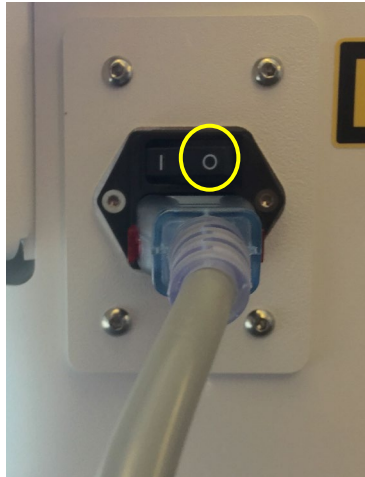

Figure 3-49. Power Off Position

3.21 Accessing the Options Menu

- From the Patient List homescreen, press the “Options” button to display the 4 Options menus, as shown in Figures 3-50.

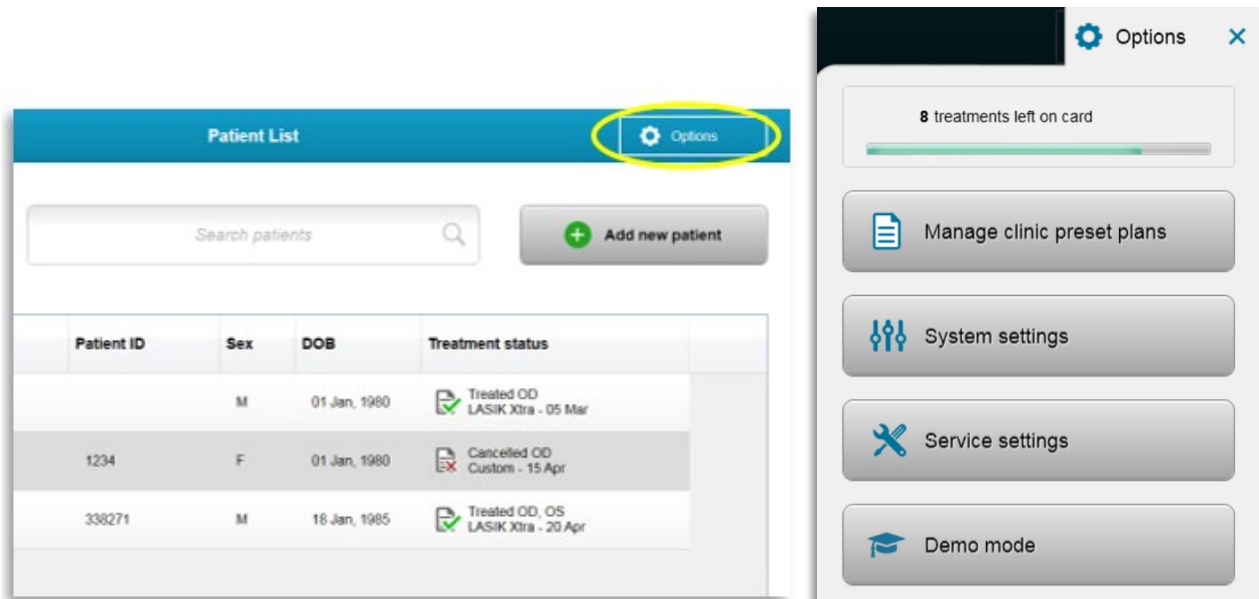

Figure 3-50. Press the “Options” button

3.21.1 Manage Clinic Preset Plans

- Select “Manage clinic preset plans” to alter any Custom preset treatment plans.
- Upto 4 clinic preset plans may be saved.

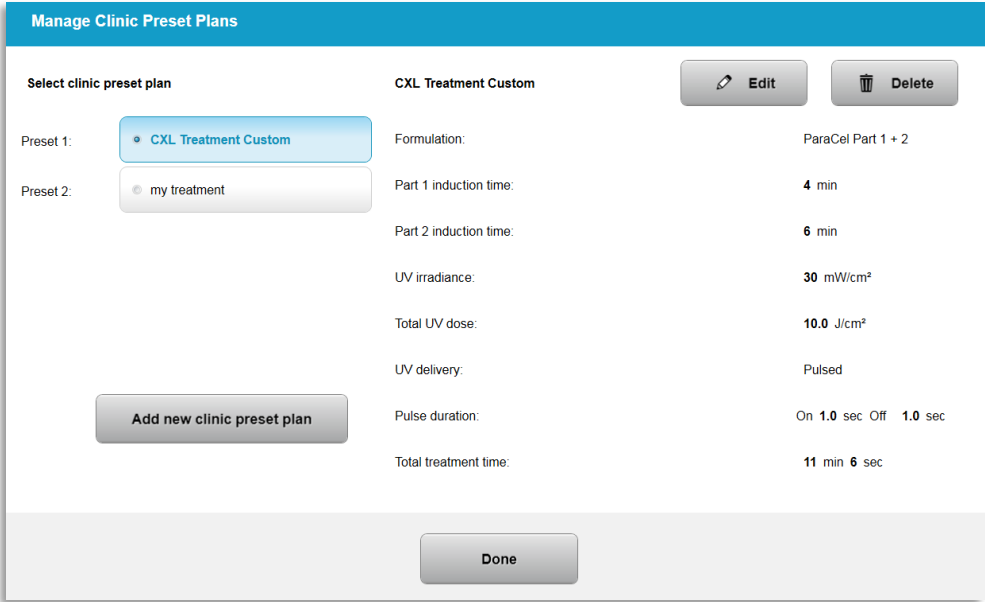

Figure 3-51. Manage Clinic Preset Plans

3.21.2 System Settings Menu

- o Select “System settings” from the Options menu to access the System settings shown in Figure 3-52.

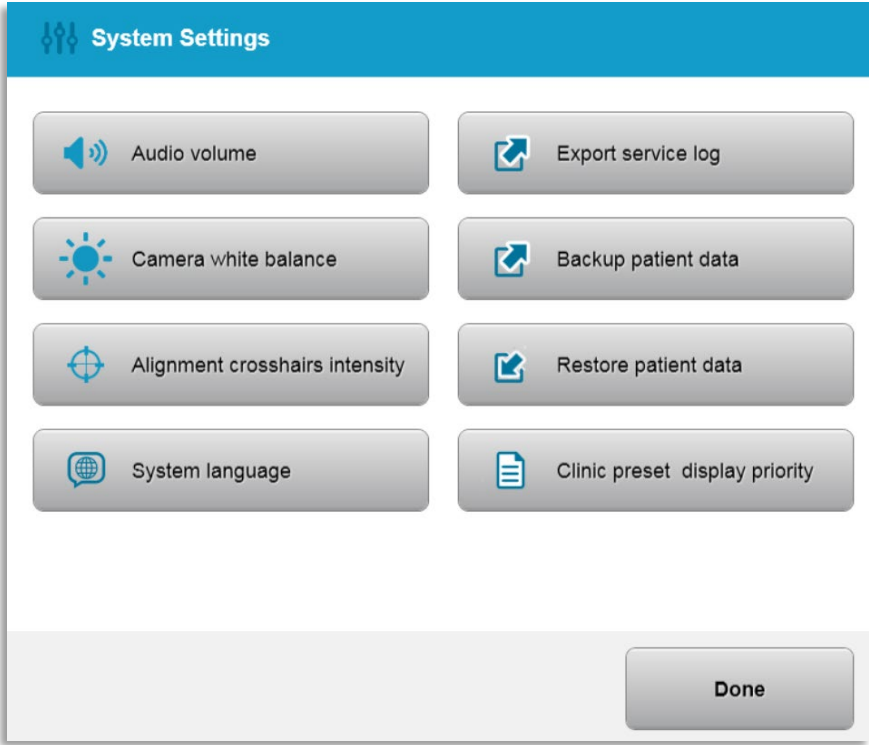

Figure 3-52. System Settings Menu

3.21.3 System Settings – Altering the System Volume

- o Select “Audio Volume” from the System Settings menu to alter the sound volume level.

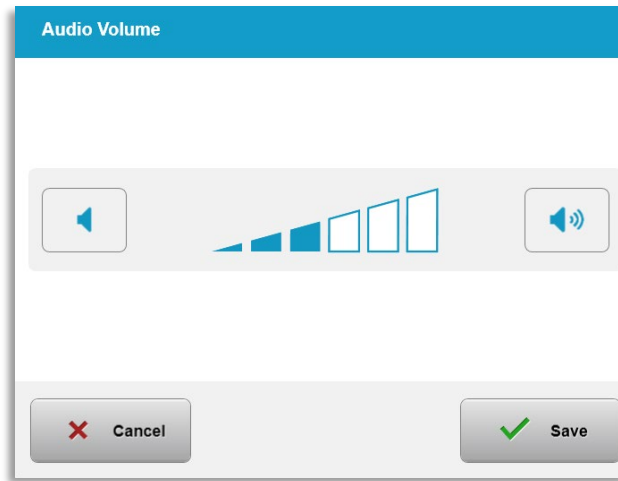

Figure 3-53. Edit Volume

3.21.4 System Settings – Altering Camera White Balance

- o Select “Camera white balance” from the System Settings menu to change the light conditions within the console.
- o Select desired white balance and click “Save” to return to the System Settings menu.
- o **NOTE:** Typical office lighting is under 5000K. As a result, the System default setting is Tungsten 2800K. If a different light source is used, it may be useful to edit the white balance condition.

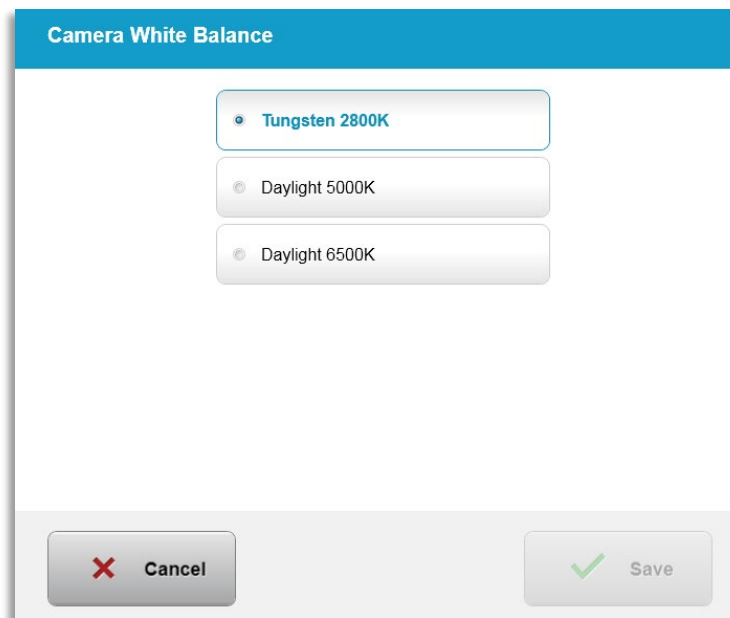

Figure 3-54. Edit Camera White Balance

3.21.5 System Settings – Altering Alignment Crosshairs’ Intensity

- Select “Alignment Crosshairs Intensity” from the System Settings menu to alter the brightness of the alignment crosshairs. The screen shown in Figure 3-55 will appear.
- Adjust crosshair brightness and select “Save.”

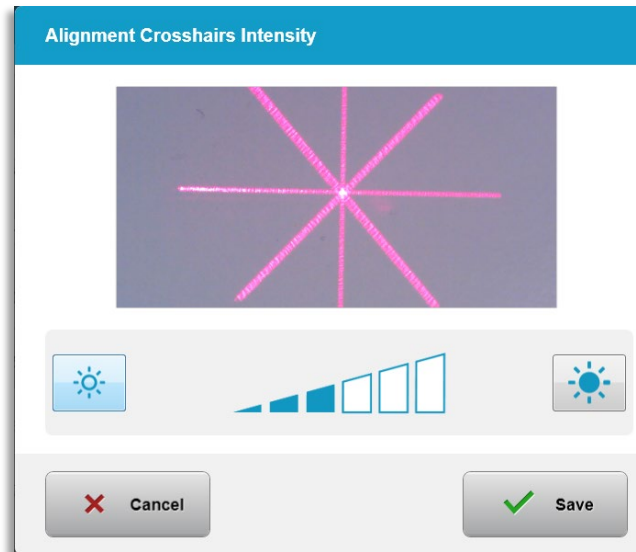

Figure 3-55. Alignment Crosshairs Intensity

3.21.6 System Settings – Selecting a Different System Language

- Select “System Language” to change the language of the Graphical User Interface.
- Select the desired language from the menu as shown in Figure 3-56.

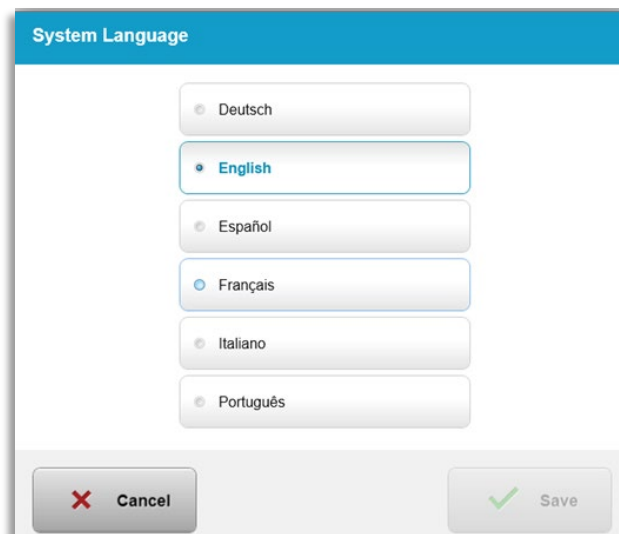

Figure 3-56. Edit System Language

3.21.7 System Settings – Export Service Log

- Select “Export service log” from the System Settings menu.
- Follow onscreen instructions to insert a USB drive to the USB port as shown in Figure 3-57.

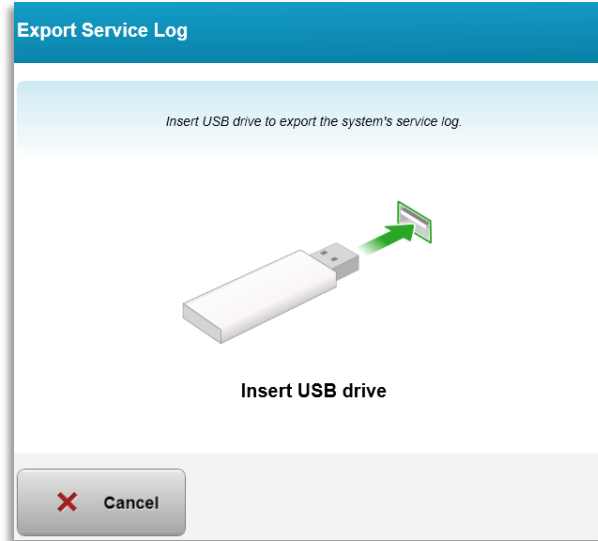

Figure 3-57. Export Service Log to USB

- The System automatically begins transferring the service log and shows a progress bar of the transfer process as shown in Figure 3-58.

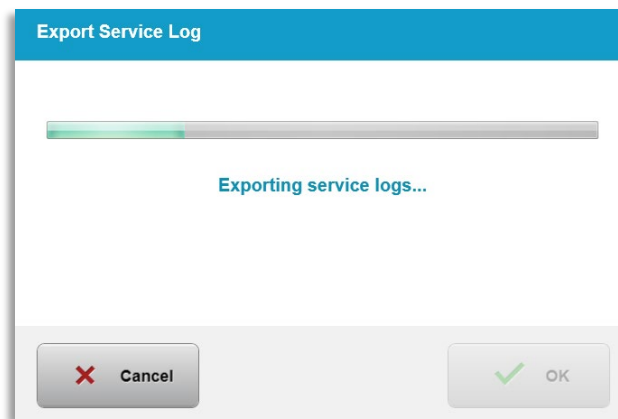

Figure 3-58. Export Service Log in Progress

- Once the export is complete, press the “OK” button to return to the System Settings menu.

3.21.8 System Settings – Backing up and Restoring Patient Data

- Patient Data may be backed up onto a USB and saved for a later time off the System by selecting “Back up Patient Data” from the Options menu.

- Patient Data that was previously saved onto a USB can be restored to the System by selecting “Restore patient data” from the Options menu.

3.21.9 System Settings – Clinic Preset Display Priority

- The Treatment Plan screen displays the KXL Defaults initially
- To display the Custom tab as the primary treatment plan tab instead of KXL Defaults tab, select “Custom” from the “Clinic preset display priority” menu.

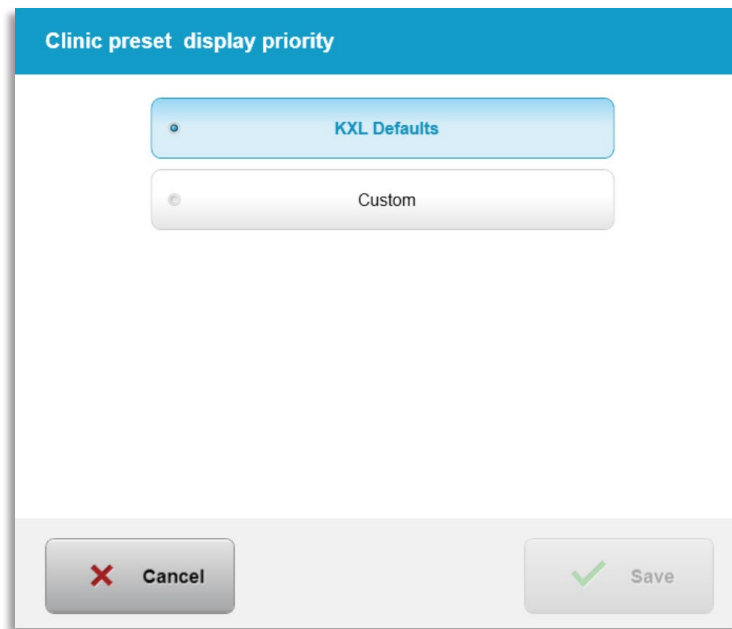

Figure 3-59. Clinic Preset Display Priority

3.21.10 Service Settings

- Service Settings are only available to Avedro and Service personnel with a KXL Advanced Settings access card.
- If selected, the user will be prompted to scan an access card.

3.21.11 Demo Mode

NOTE: Not for use in treating patients

- Demo mode allows users to train on use of the KXL System without requiring treatment cards and without using UV light.
 - Select “Demo Mode”
 - Select “Start” to use the System in Demo Mode
- The KXL System screens will indicate that the System is currently in “Demo Mode” as shown in Figure 3-60 and Figure 3-61.
- To exit “Demo Mode,” select “Exit Demo Mode” from the Patient List screen.

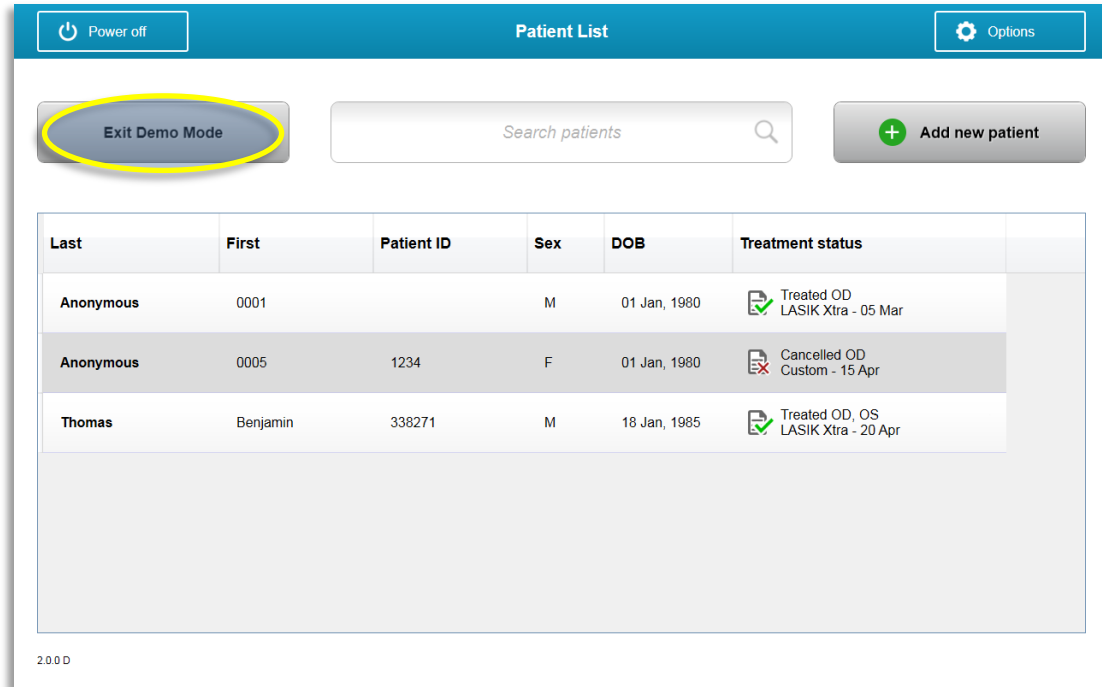

Figure 3-60. Patient List Indicates Demo Mode

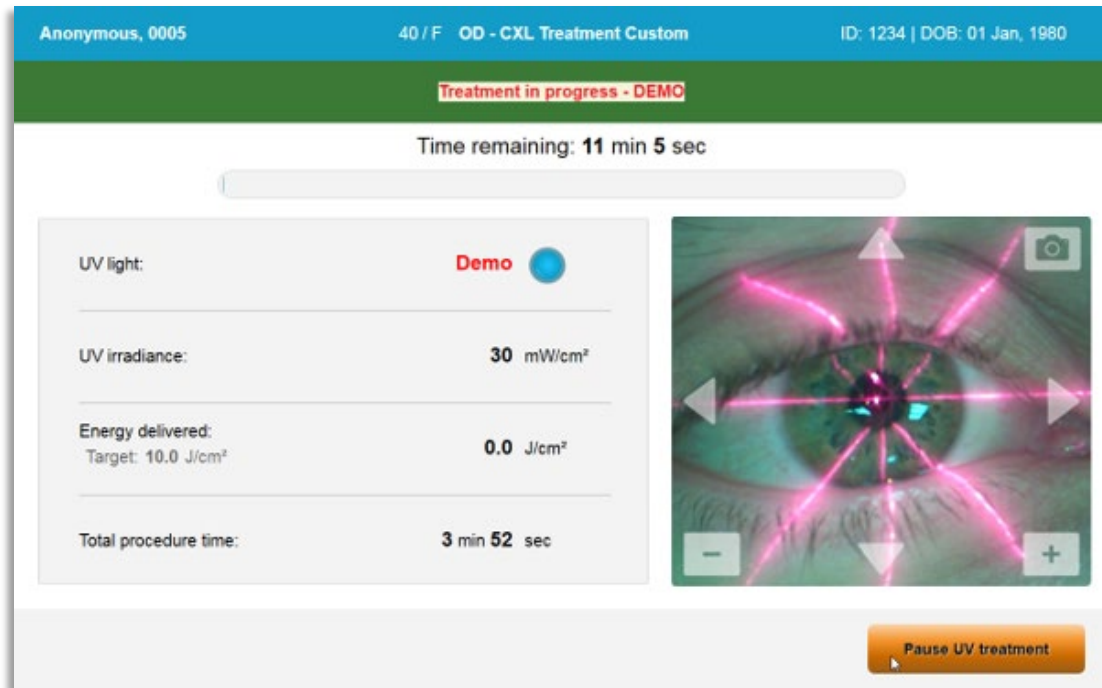

Figure 3-61. Demo Mode is Indicated at Top of Screen

4 Maintenance / Service

By definition, “maintenance” refers to those non-technical procedures an everyday operator must perform to keep the system working properly. The word “service,” by contrast, refers to tasks that are intended to be performed only by a qualified service representative.

4.1 Installation Policy

- For each new KXL System customer, an Avedro trained or authorized personnel provides a full initial installation and start-up of the system. Following initial installation and once the system is operating properly, this Avedro representative may also provide basic training to a designated operator about the basic operation of the KXL System.
- Consequently, this manual does not include any specific instructions relating to installation or set-up of the system. Per your service agreement, any further hardware adjustment, other than what is specified for normal operation, should be performed by, or with the guidance of, an Avedro-authorized distributor.

4.2 Customer Maintenance

- In general, there is no customer maintenance required for The KXL System. All technical maintenance or service will be performed by a qualified service representative while under service contract. If you have trouble with your system, refer to the Troubleshooting section below or call your local Avedro Representative.

4.3 Warranty Information

- A Warranty is supplied separately with the purchasing information.

4.4 Service Contract Information

- A service contract is available on all KXL Systems. The contract provides for regularly scheduled service and field upgrades. It also provides for any non-scheduled service calls that may be necessary.

4.5 Per Patient Disposables

- Per Patient Disposables can be ordered from Avedro or your Avedro-authorized distributor. **Use only Avedro products or Avedro-approved products with your KXL System.** Avedro shall

not be liable for damage to or malfunction of the system, which it deems, was caused by the use of unauthorized materials.

4.6 Trouble Shooting

- The KXL System checks its status at start-up automatically. If the status is incorrect, the software prevents the operator from initiating treatments.

4.6.1 Wireless Remote

- The KXL System uses a remote control with replaceable batteries. To change the batteries in the remote control, slide the front of the remote with buttons backward while pressing the back of the remote in the opposite direction. See Figure 4.1.



Figure 4-1. Access Battery Compartment

- If the batteries run low, the System will lose its connection with the remote and notify the user of the need to try again. If the remote fails to sync, select “Continue Without Remote” or “Cancel Treatment.”
- Figure 4.1 depicts onscreen guidance for KXL Systems using the Original Remote; Figure 4.2 depicts onscreen guidance for KXL Systems using the Updated Remote.

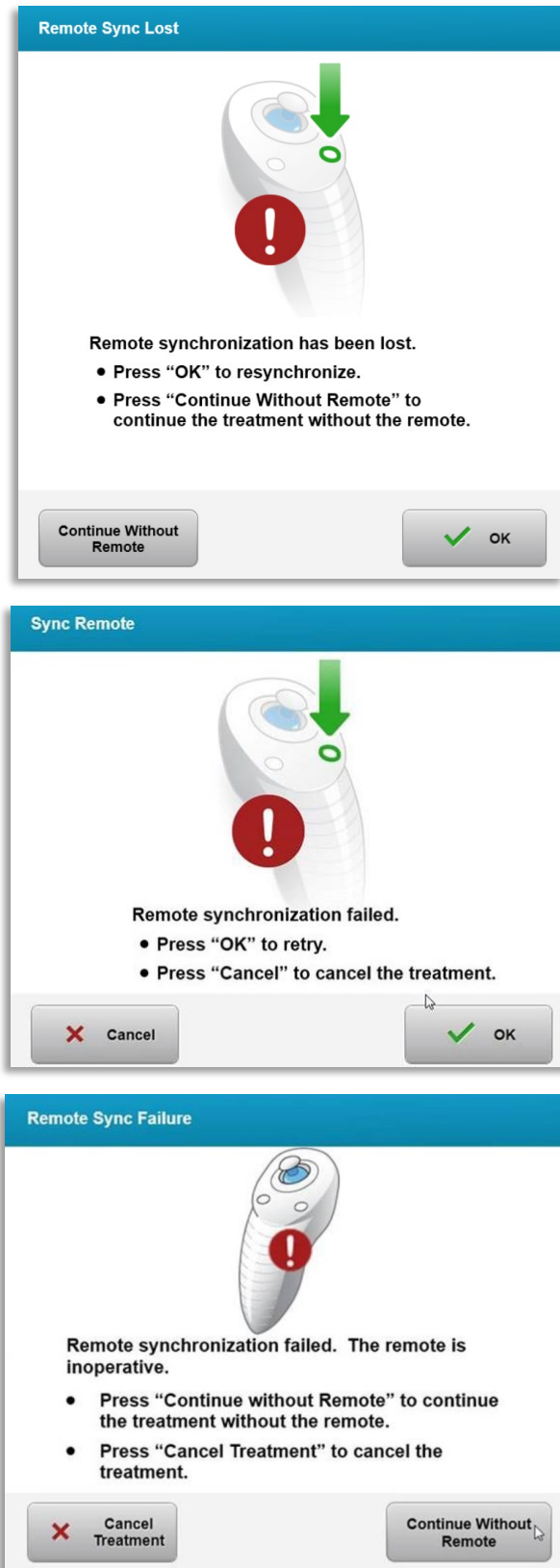

Figure 4-2. Alignment Remote Lost Sync – Original Remote

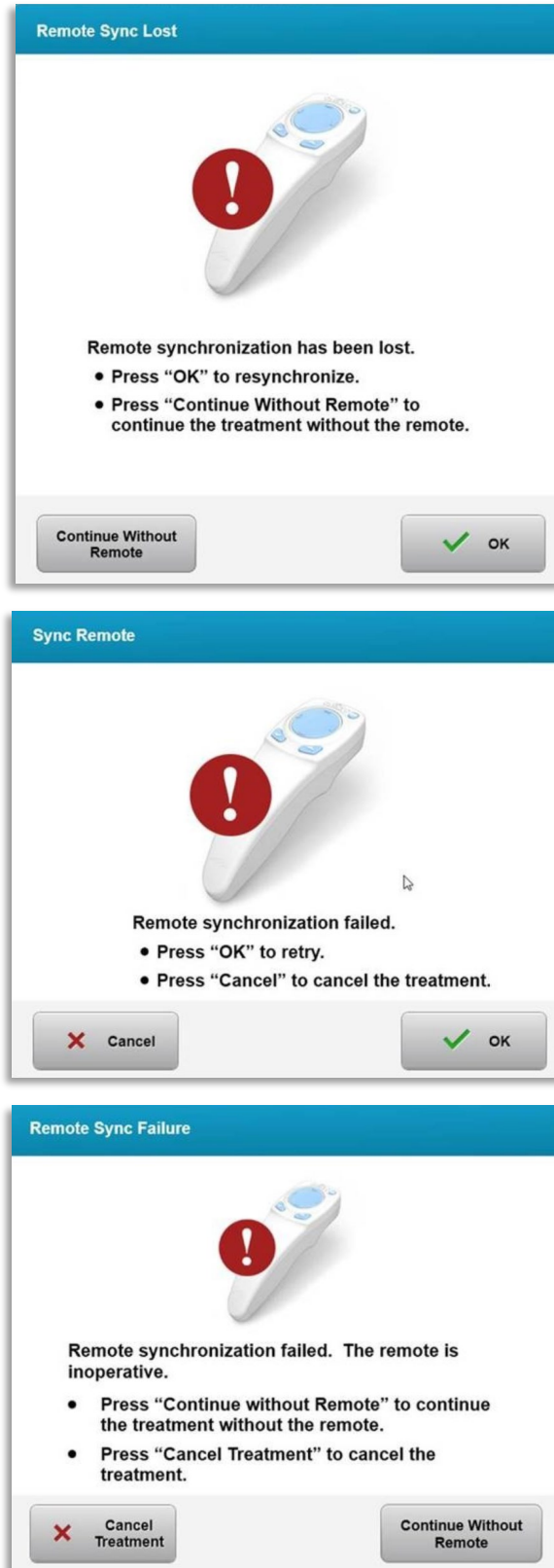

Figure 4-3. Alignment Remote Lost Sync - Updated Remote

- Original Remote
 - If light on the remote is flashing two times per second, the remote’s batteries need to be changed.
 - If the light on the remote is flashing once per second, then it is not synchronized.
 - If the remote does not re-synchronize by pressing the “Sync” button, replace the batteries.
- Updated Remote
 - If battery status light is orange, the remote’s batteries need to be changed shortly.
 - If the battery status light is flashing orange, the remote’s batteries need to be changed immediately – There is not enough power to complete a treatment with the remote.
- If replacing the batteries does not allow the System to synchronize, contact your local Avedro Service Representative.

4.7 Directions for Disinfection

- No components of the KXL System are designed to be sterilized by the operator.
- ONLY external cleaning and disinfection is recommended.
 - For disinfection purposes, use only 70% isopropyl alcohol preparations or 10% bleach solutions. Use soft fiber-free wipes.

4.8 Cleaning the System

- Use a soft damp cloth to clean the KXL System.
- The exterior of the System can be cleaned using a lint-free cloth dampened with dilute bleach, soapy water, or isopropyl alcohol.
- A 70% isopropyl alcohol or 10% chlorine bleach solution can also be used if necessary.
- DO NOT submerge the System in liquid or pour liquid onto the system.



CAUTION: Power down the system and remove the power supply cord from the main outlet prior to any cleaning procedure.



CAUTION: The glass window of the beam aperture must not under any circumstances be in contact with any aggressive cleaning agents.

- While cleaning the surfaces of the device, ensure that cleaning fluids do not seep inside the device, as this leakage can damage the device.
- Use a lint-free cloth dampened with isopropyl alcohol to clean the remote control.

4.9 Cleaning the Aperture

- Check the beam aperture routinely prior to treatment.
- Use camera lens wipes or compressed air to remove dust and particles from the glass surface of the aperture.

4.10 Articulating Arm Adjustment

If the articulating arm does not hold the Optical Head in a fixed vertical position, follow the steps outlined below to counterbalance the articulating arm.

- Cycle the arm up and down through its full range of motion and set the arm horizontal, i.e. approximately parallel to the floor.

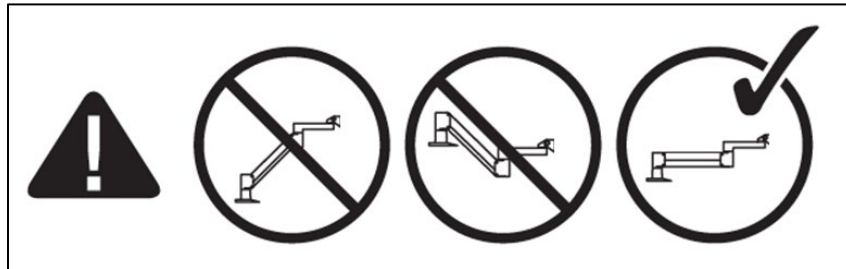

Figure 4-4. Position the Arm Parallel to the Floor

- If the arm drifts downward, lift the arm to the top of its range and loosen Counterbalance Set Screw A by turning the screw at least a ½ turn. Use a 3/32 Allen Wrench. See Figure 4-5.

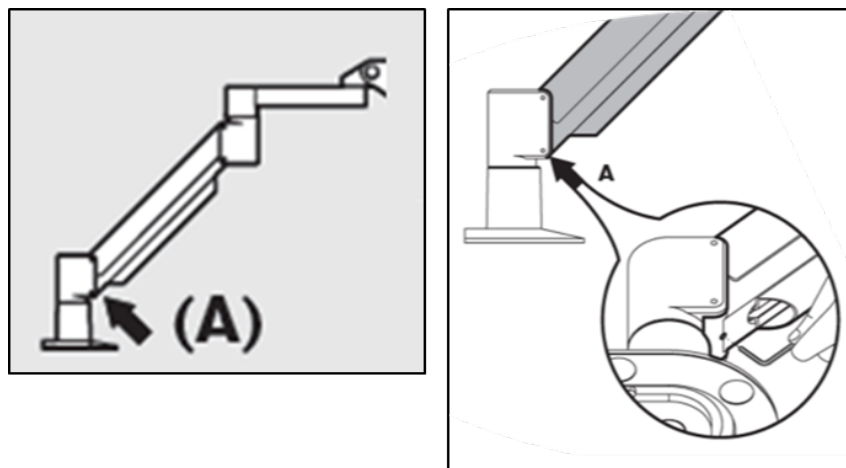

Figure 4-5. Loosen Counterbalance Set Screw A

- Reposition the arm horizontally. Loosen the upper **Counterbalance Set Screw B** by turning the screw at least a ½ turn. Use a 3/32 Allen Wrench. See Figure 4-6.

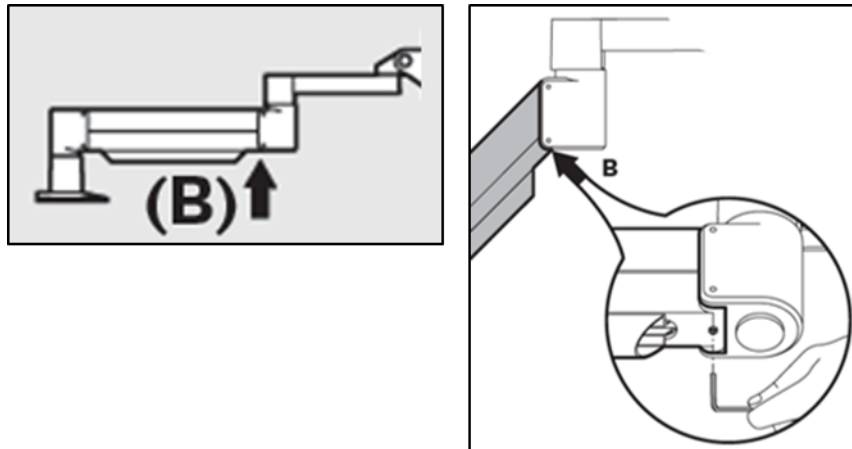

Figure 4-6. Loosen Counterbalance Set Screw B

- Maintain the horizontal arm position by supporting load as needed.
- Set the arm tension with the **Strength Adjustment Screw C**. Use a 7/32 Allen Wrench and turn the Screw C counter clockwise until the arm just begins to move slowly upward. There should be a slight bounce-back when the arm is lightly tapped down after adjustment. See Figure 4-7.

NOTE: 15-20 turns may be needed. If the arm continues to droop and the screw cannot be turned further, contact your local Avedro service representative.

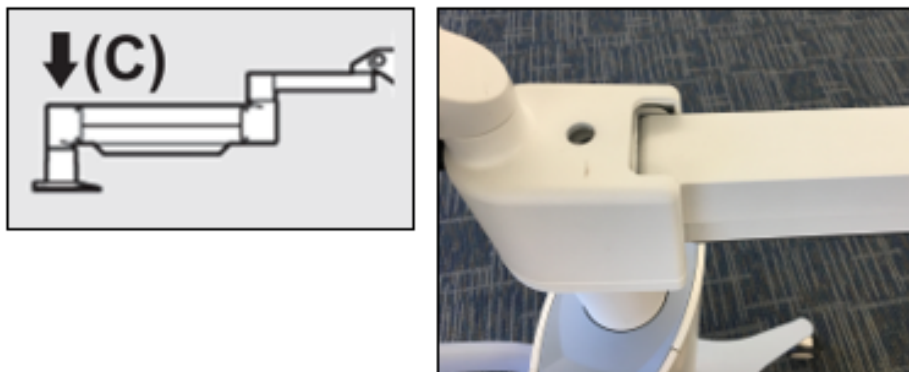

Figure 4-7. Set Arm Tension with Strength Adjustment Screw C

- Turn **Strength Adjustment Screw C** two full revolutions in the clockwise direction.
- Ensure that the arm is stationary to barely creeping upward.
- Raise the arm to the highest position and tighten **Counterbalance Set Screw A** until contact is made, then tighten ½ to ¾ max revolutions. See Figure 4-5.

- Position the arm horizontally and tighten **Counterbalance Set Screw B** until contact is made, then tighten $\frac{1}{2}$ to $\frac{3}{4}$ revolutions. See Figure 4-6.
- Cycle the arm up and down through its full range of motion. Ensure there is no upward or downward drift.
- **NOTE:** If the arm drifts upward from any position, return to horizontal and turn **Strength Adjustment Screw C** clockwise $\frac{1}{4}$ revolution at a time until it no longer rises on its own.

4.11 Moving the System

- The KXL is designed as a movable system within an office environment. If it ever proves necessary to transport or ship the KXL System, for any reason, contact your local Avedro representative. Packing and transporting the system should be performed only by Avedro trained and authorized personnel.
- Prior to moving the KXL System from one room to another, the monitor should be moved sideways, and the KXL Head should be positioned close to the cart handle with the elbow protruding at the back. The system can then be easily pushed by the cart handle through the door frame.



Figure 4-8. Moving System Configuration

4.12 Storing the System

- Follow all the storage temperature and humidity range specifications as listed in Chapter 7.0 - Specifications.
- Close all panels on the system to prevent dust and moisture from entering; this is mandatory.
- Turn OFF all the components and switch off the master power switch as well. Disconnect the power cord from its electrical outlet. Remove the batteries from the wireless remote.
- Do not disassemble any part of the system as this could cause misalignment or damage.

4.13 Software

- Should the software become corrupted and fail to work correctly, call your local Avedro service representative. Software updates will only be carried out by Avedro service representatives.

4.14 Risks Associated with Disposing of Waste Products

- When disposing of waste products, follow all applicable local regulations.

4.15 Performing a Visible Check

- Check all components of the device routinely for damage or malfunction prior to each treatment.

5 Equipment Classification

According to EN60601-1 Medical Device Electrical Standard

- Protection against electrical shock
 - Class 1 (external electrical power source)
- Degree of protection against electric shock
 - Not classified, equipment not provided with applied part
 - System ingress protection: IP20 (No protection against ingress of water)
 - Updated remote ingress protection: IP53
- Method of sterilization or disinfection
 - Disinfect-able device
 - Degree of protection for use in the presence of a flammable as aesthetic mixture
 - No protection
 - Use conditions
 - Continuous service

According to FCC Part 15, EN55011 and EN60601-1-2

- Class B

According to EN60825-1 Safety of laser productions

- Alignment lasers are Class 1 Laser Product

According to EN62471 Photobiological safety of lamps and lamp systems

- IEC 62471:2006 Risk Group 2
- EN 62471:2008 Risk Group 3
- UVA LED is Risk Group 3

According to Annex II.3 of Directive 93/42/EEC

- Class IIa

EMC Requirements



The KXL System requires special precautions regarding electromagnetic compatibility (EMC). Installation and use should be carried out according to the EMC information provided in this manual. Portable and mobile RF communications equipment may affect the KXL System.

Guidance and manufacturer's declaration - electromagnetic emissions		
The KXL System is intended for use in the electromagnetic environment specified below. The customer or the user of the KXL System should assure that it is used in such an environment.		
Emissions test	Compliance	Electromagnetic environment – guidance
RF emissions CISPR 11	Group 1	The KXL System uses RF energy only for its internal function. Therefore, its RF emissions are very low and are not likely to cause any interference in nearby electronic equipment.
RF emissions CISPR 11	Class B	The KXL System is suitable for use in all establishments including domestic establishments and those directly connected to the public low-voltage power supply network that supplies buildings used for domestic purposes.
Harmonic emissions IEC 61000-3-2	Class A	
Voltage fluctuations/ flicker emissions IEC 61000-3-3	Complies	

Guidance and manufacturer's declaration – electromagnetic immunity			
The KXL System is intended for use in the electromagnetic environment specified below. The customer or the user of the KXL System should assure that it is used in such an environment.			
Immunity test	IEC 60601 test level	Compliance level	Electromagnetic environment - guidance
Electrostatic discharge (ESD) IEC 61000-4-2	±8 kV contact ±15 kV air	±8 kV contact ±15 kV air	Floors should be wood, concrete or ceramic tile. If floors are covered with synthetic material, the relative humidity should be at least 30%.
Electrical fast transient/burst IEC 61000-4-4	±2 kV for power supply lines ±1 kV for input/output lines	±2 kV for power supply lines Not Applicable Input /Output Lines	Mains power quality should be that of a typical commercial or hospital environment.
Surge IEC 61000-4-5	±1 kV line(s) to line(s) ±2 kV line(s) to earth	±1 kV line(s) to line(s) ±2 kV line(s) to earth	Mains power quality should be that of a typical commercial or hospital environment.
Voltage dips, short interruptions and voltage variations on power supply input lines IEC 61000-4-11	0 % UT (100 % dip in UT) for 0.5 cycle 0% UT (100% dip in UT) for 1 cycles 70% UT (30% dip in UT) for 25/30 cycles 0% UT (100 % dip in UT) for 5 sec	0 % UT (100 % dip in UT) for 0.5 cycle 0% UT (100% dip in UT) for 1 cycles 70% UT (30% dip in UT) for 25/30 cycles 0% UT (100 % dip in UT) for 5 sec	Mains power quality should be that of a typical commercial or hospital environment, If the user of the KXL System requires continued operation during power mains interruptions, it is recommended that the KXL System be powered from an uninterruptible power supply or a battery.
Power frequency (50/60 Hz) magnetic field IEC 61000-4-8	30 A/m	30 A/m	Power frequency magnetic fields should be at levels characteristic of a typical location in a typical commercial or hospital environment.
NOTE: UT is the a.c. mains voltage prior to application of the test level.			

Guidance and manufacturer's declaration — electromagnetic immunity			
The KXL System is intended for use in the electromagnetic environment specified below. The customer or the user of the KXL System should assure that it is used in such an environment.			
Immunity test	IEC 60601 test level	Compliance level	Electromagnetic environment — guidance
Conducted RF IEC61000-4-6	3 Vrms 150 kHz to 80 MHz	3 Vrms	Portable and mobile RF communications equipment should be used no closer to any part of the KXL System, including cables, than the recommended separation distance calculated from the equation applicable to the frequency of the transmitter. Recommended separation distance $d = 1,2\sqrt{P}$ 80 MHz to 800 MHz $d = 1,2\sqrt{P}$ $d = 1,2\sqrt{P}$ $d = 2,3\sqrt{P}$ 80 MHz to 2.7 GHz where P is the maximum output power rating of the transmitter in watts (W) according to the transmitter manufacturer and d is the recommended separation distance in metres (m). Field strengths from fixed RF transmitters, as determined by an electromagnetic site survey,a should be less than the compliance level in each frequency range.b Interference may occur in the vicinity of equipment marked with the following symbol: 
Radiated RF IEC 61000-4-3	3 V/m 80 MHz to 2.7 GHz	3V/m	
Proximity fields from RF wireless communications equipment (IEC 61000-4-3:2006 A1:2007 A2:2010)	15 specific frequencies. Immunity level 9-28V/m	15 specific frequencies. Immunity level 9-28V/m	
<p>NOTE 1 At 80 MHz and 800 MHz, the higher frequency range applies.</p> <p>NOTE 2 These guidelines may not apply in all situations. Electromagnetic propagation is affected by absorption and reflection from structures, objects and people.</p> <p>a Field strengths from fixed transmitters, such as base stations for radio (cellular/cordless) telephones and land mobile radios, amateur radio, AM and FM radio broadcast and TV broadcast cannot be predicted theoretically with accuracy. To assess the electromagnetic environment due to fixed RF transmitters, an electromagnetic site survey should be considered. If the measured field strength in the location in which the KXL System is used exceeds the applicable RF compliance level above, the KXL System should be observed to verify normal operation. If abnormal performance is observed, additional measures may be necessary, such as re-orienting or relocating the KXL System.</p> <p>b Over the frequency range 150 kHz to 80 MHz, field strengths should be less than 3 V/m.</p>			









Recommended separation distances between portable and mobile RF communications equipment and the KXL System			
<p>The KXL System is intended for use in an electromagnetic environment in which radiated RF disturbances are controlled. The customer or the user of the KXL System can help prevent electromagnetic interference by maintaining a minimum distance between portable and mobile RF communications equipment (transmitters) and the KXL System as recommended below, according to the maximum output power of the communications equipment.</p>			
Rated maximum output power of transmitter (W)	Separation distance according to frequency of transmitter m		
	150 kHz to 80 MHz $d = 1.2\sqrt{P}$	80 MHz to 800 MHz $d = 1.2\sqrt{P}$	800 MHz to 2.5 GHz $d = 2.3\sqrt{P}$
0.01	0.12	0.12	0.23
0.1	0.38	0.38	0.73
1	1.2	1.2	2.3
10	3.8	3.8	7.3
100	12	12	23
<p>For transmitters rated at a maximum output power not listed above, the recommended separation distance d in metres (m) can be estimated using the equation applicable to the frequency of the transmitter, where P is the maximum output power rating of the transmitter in watts (W) according to the transmitter manufacturer.</p> <p>NOTE 1 At 80 MHz and 800 MHz, the separation distance for the higher frequency range applies.</p> <p>NOTE 2 These guidelines may not apply in all situations. Electromagnetic propagation is affected by absorption and reflection from structures, objects and people.</p>			







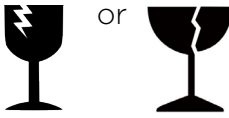
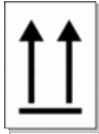

The KXL System contains an RFID function which transmits and receives at the 13.56 MHz frequency. This functionality may be interfered with by other equipment, even if that other equipment complies with CISPR emission requirements.

The KXL System contains the following RF transmitters:
RFID Reader
<ul style="list-style-type: none"> • 13.56MHz Reader/Writer • Integral Antenna: Maximum 4” Read Range • Max output power is 200mW • Meets: ISO18000-3, ISO15693

6 Symbol Library

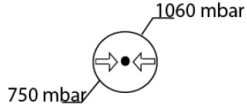
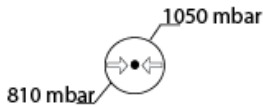
Text Symbol	Symbol Illustration	Definition
1. No AP symbol in presence of flammable anesthetics		Danger, Risk of Explosion. Not for use
2. AC symbol		Alternating current
3. "I" in a book		Attention: Consult ACCOMPANYING DOCUMENTS
4. Ground symbol in circle		Protected earth (ground)
5. Ingress Protection Symbol	IP20 <i>(original remote)</i> IP53 <i>(updated remote)</i>	Ingress Protection (solids under 12.5 mm and no protection against water)
6. Power button		Standby
7. Power Switch		ON
8. Power Switch	○	OFF
9. CE Mark		Conformity mark
10. Manufacturer		Name and address of the manufacturer
11. ! in a Triangle		Caution specific warning in operators manual
12. Net Weight (kgs) Gross Weight (kgs)	NW GW	Weight
13. Umbrella with raindrops		Keep Dry: Store protected from moisture (symbol is with or without rain drops)

Text Symbol	Symbol Illustration	Definition
14. Broken glass		Contents are fragile, handle with care
15. Two up arrows		Keep arrows on carton pointing up
16. Water drop in a box		Humidity limits (percentages below symbol are the acceptable range for humidity)
17. Operating Temperature limits		Operating Temperature limits
18. Storage Temperature limits		Storage Temperature limits
19. MR crossed in a circle		MR Unsafe - Keep away from magnetic resonance imaging (MRI) equipment
20. Storage Pressure limits		Storage Atmospheric pressure limits
21. Operating Pressure limits		Operating Atmospheric pressure limits
22. Signal emitted		RF transmitted through device

7 Specifications

Specification	Description
Electrical	Line voltages 100 - 240 volts AC Current 2A - 1A Single Phase RMS, 50/60 Hz Original Remote 2x AAA batteries Updated Remote 2x AA batteries
List of cables and Accessories	Wireless Remote Hospital Grade AC power cable (Lockable/Detachable)
Energy Delivery	UV Radiation 3 - 45 mW/cm ² 365 nm
UVA LED Light Source	UV Radiation 365 nm
External Interfaces	USB 2.0
Physical Dimensions	No larger than 60 x 60 x 150 cm (Length x Width x Height)
Weight (crated system)	NW 48 Kg GW 120 Kg
Remote Battery Life (normal operating conditions)	18 hours
Remote and Dongle FCC ID and Operating Frequencies	FCC ID: SXJ87027-TX (original remote) FCC ID: 2AVGK-KXLTX (updated remote) 2.405-2.475 GHz.
Environmental Operating Conditions	The system operates under the following atmospheric conditions (no condensation).
Ambient temperature	+15 to +30 °C
Relative humidity	20% to 80%, non-condensing
Atmospheric pressure	810 to 1050 mbar
Transport and Storage Conditions	The instrument withstands the following transport and storage conditions without damage or performance deterioration.
Ambient temperature	-15 to +60 °C
Relative humidity	10% to 80% non-condensing
Atmospheric pressure	750 to 1060 mbar