

---

# Avedro, Inc. KXL<sup>®</sup> System

---

## Operator's Manual



Copyright 2023. Avedro, a Glaukos Company. All Rights Reserved  
Printed in U.S.A.

## **Patents, Trademarks, Copyrights**

The KXL® System may be covered by one or more patent applications issued or pending in the United States and worldwide.

“KXL®” and the Avedro logo design are registered trademarks or trademarks of Avedro, Inc. All software and documentation are subject to Avedro, Inc. copyrights. Avedro is a wholly owned subsidiary of GLAUKOS Corporation. All rights reserved 2023.

Microsoft and Windows are registered trademarks and trademarks, respectively, of Microsoft Corporation. Any other trademarks or service marks contained within this manual are the property of their respective owners.

**For more information, contact:**  
Avedro, a Glaukos Company



Avedro, a Glaukos Company  
30 North Ave  
Burlington, MA 01803  
+1-844-528-3376

---

---

# Table of Contents

<b>1</b>	<b>Foreword</b>	<b>1</b>
1.1	Intended Use of Manual	1
1.2	Intended Use / Indications for Use	1
1.3	Design Change Disclaimer	1
1.4	Reproduction Disclaimer	1
1.5	User Operation Assistance Statement	2
1.6	Contraindications, Warnings and Cautions	2
1.6.1	Contraindications	2
1.6.2	Warnings	2
1.6.3	Electrical Safety Warnings	2
1.6.1	Radiation Safety Warnings	6
1.7	Patient Safety	6
1.8	Additional Safety Considerations	6
1.9	FCC Compliance Notice	6
<b>2</b>	<b>Introduction</b>	<b>8</b>
2.1	System Overview	8
2.1.1	Major Components	9
<b>3</b>	<b>System Operation</b>	<b>12</b>
3.1	Charging the KXL System Battery	12
3.2	Touchpad/Keyboard Use	13
3.3	UV Dose	14
3.3.1	Continuous Mode	14
3.3.2	Pulsed Mode	14
3.4	Preparing the System	14
3.5	Important Steps Before Turning on the System	15
3.6	Powering Up the System	15
3.7	Set Riboflavin Induction Period	16
3.8	Select UV Treatment Mode	17
3.8.1	Continuous UV Treatment Mode	17
3.8.2	Pulsed UV Treatment Mode	18
3.9	Starting Treatment	20
3.9.1	Single-use Disposables	20
3.9.2	Multi-use Disposables	21
3.9.3	RFID Card Controlled Limits	22
3.9.4	Sync Alignment Remote	22
3.10	Preparing the Patient	23
3.11	Alignment of the Device	24
3.12	Initiating Treatment	26
3.13	Monitoring Treatment	26

---

3.14	Stopping a Treatment .....	27
3.15	Treatment Complete .....	28
3.16	Pausing or Canceling a Treatment .....	29
3.17	Powering Down the System.....	30
3.18	Checking KXL System Battery Function after Storage .....	31
3.19	Using the Device Settings Menu .....	32
3.19.1	Advanced Settings .....	32
3.19.2	Editing System Language .....	32
3.19.3	Editing Alignment Crosshairs Intensity .....	33
3.19.4	Editing System Volume.....	33
3.19.5	Copying Treatment Data to USB.....	33
3.19.6	Editing Default Treatment Parameters.....	35
<b>4</b>	<b>Maintenance / Service .....</b>	<b>36</b>
4.1	Installation Policy.....	36
4.2	Customer Maintenance .....	36
4.3	Warranty Information .....	36
4.4	Service Contract Information .....	36
4.5	Per Patient Disposables .....	37
4.6	Troubleshooting .....	37
4.6.1	Wireless Remote .....	37
4.6.2	Internal Rechargeable Battery .....	38
4.7	Directions for Sterilization or Disinfection.....	38
4.8	Cleaning the System .....	38
4.9	Cleaning the Aperture .....	38
4.10	Articulating Arm Adjustment.....	39
4.11	Moving the System .....	42
4.12	Storing the System.....	42
4.13	Software .....	43
4.14	Identifying Risks Associated with Disposing of Waste Products.....	43
4.15	Performing a Visible Check .....	43
<b>5</b>	<b>Equipment Classification .....</b>	<b>44</b>
5.1	Equipment Classification .....	44
5.2	EMC Guidance .....	45
5.3	RF Transmitters.....	<b>Error! Bookmark not defined.</b>
5.3.1	RFID Reader .....	49
5.3.2	Wireless Remote Control .....	49
<b>6</b>	<b>Symbol Library .....</b>	<b>50</b>
<b>7</b>	<b>Specifications .....</b>	<b>52</b>

---

---

# Table of Figures

Figure 2-1. Overview Illustration of KXL System.....	9
Figure 2-2. System Illustrations with Callouts .....	10
Figure 2-3. Wireless Remote .....	10
Figure 2-4. KXL Label.....	11
Figure 2-5. UV Emitting Label .....	11
Figure 2-6. Alignment Laser Classification Label .....	11
Figure 3-1. Power Switch .....	15
Figure 3-2. Startup Screen .....	16
Figure 3-3. Induction Period Screen .....	16
Figure 3-4. Select Continuous Treatment Mode Screen .....	17
Figure 3-5. Continuous UV Treatment Parameters Screen .....	18
Figure 3-6. Confirm Continuous Treatment Parameters Screen .....	18
Figure 3-7. Select Continuous Treatment Mode Screen .....	18
Figure 3-8. Pulsed UV Treatment Parameters Screen .....	19
Figure 3-9. Set Pulsed UV Cycle Times Screen.....	19
Figure 3-10. Confirm Pulsed UV Treatment Parameters Screen .....	20
Figure 3-11. Reading Activation Card .....	20
Figure 3-12. Treatments Remaining .....	21
Figure 3-13. Final Treatment .....	21
Figure 3-14. No Treatments Remaining.....	22
Figure 3-15. Invalid Treatment Parameters.....	22
Figure 3-16. Remote Sync Status.....	23
Figure 3-17. Prepare Patient Screen.....	24
Figure 3-18. Align Crosshairs During Induction .....	25
Figure 3-19. Remote Functions .....	25
Figure 3-20. Red Crosshairs X & Y Axes, Red Crosshairs Z Axis Alignment .....	25
Figure 3-21. Induction Complete .....	26
Figure 3-22. Treatment Screen.....	27
Figure 3-23. Treatment Paused Screen .....	27
Figure 3-24. Treatment Complete Screen .....	28
Figure 3-25. Confirm Cancel Session Screen .....	29
Figure 3-26. Confirm Cancel Partial Treatment.....	29
Figure 3-27. Partial Treatment Information .....	30

---

Figure 3-28. Power Off .....	30
Figure 3-29. Power Off Position.....	30
Figure 3-30. KXL System Plug.....	31
Figure 3-31. KXL System Battery Status Indicator .....	31
Figure 3-32. Device Settings Menu.....	32
Figure 3-33. Edit System Language.....	32
Figure 3-34. Edit Alignment Crosshairs Intensity.....	33
Figure 3-35. Edit Volume .....	33
Figure 3-36. Data Transfer to USB .....	34
Figure 3-37. Edit Default UV Treatment Mode Parameters .....	35
Figure 3-38. Edit Default Treatment Parameters (Continuous & Pulsed) .....	35
Figure 3-39. Edit Default UV Pulse Parameters (Pulsed Only).....	35
Figure 4-1. Alignment Remote Lost Sync.....	37
Figure 4-2. Position the Arm Parallel to the Floor .....	39
Figure 4-3. Turn the Adjustment Screw.....	39
Figure 4-4. With Arm Raised, Tighten Set Screw (A) .....	40
Figure 4-5. With Arm Horizontal, Tighten Set Screw (B) .....	40
Figure 4-6. Summary of Further Counterbalance Adjustments .....	41
Figure 4-7. Moving System Configuration .....	42
Table 5-1. Electromagnetic Emissions .....	45
Table 5-2. Electromagnetic Immunity .....	47
Table 5-3. Electromagnetic Immunity (continued).....	47
Table 5-4. Recommended Separation Distances.....	48
Table 5-5. Highest Emissions .....	49

---

# 1 Foreword

---

## Intended Use of Manual

This manual is designed to serve the operators of the Avedro, Inc. KXL® System. All operating instructions, product illustrations, screen graphics, troubleshooting/error messages, and other relevant information are contained in this manual. It is the operator's responsibility to ensure that all safety instructions in this manual are applied strictly.

## Intended Use / Indications for Use

The KXL System delivers a uniform, metered dose of UVA light to a targeted treatment area for the intended use of illuminating the cornea during corneal cross-linking procedures stabilizing cornea which have been weakened by disease or by refractive surgery.

## Design Change Disclaimer

- Due to design changes and product improvements, information in this manual is subject to change without notice. Avedro, Inc. (hereafter called "Avedro") reserves the right to change product design at any time without notice, which may subsequently affect the contents of this manual.
- Avedro assumes no responsibility for any errors that may appear in this manual. Avedro will make every reasonable effort to ensure that this manual is up to date and corresponds with the shipped KXL System.
- The touchscreen images depicted in this manual are representative only. Depending on the software version of the system, minor differences may appear between the actual touchscreen displays and images shown in this manual.
- All patient data appearing in this document, including the sample screen graphics, are fictitious and representative only. No patient's confidentiality has been violated, with or without permission.

## Reproduction Disclaimer

Neither this manual nor any part of it may be reproduced, photocopied, or electronically transmitted in any way without the advanced written permission of Avedro, Inc.

## **User Operation Assistance Statement**

Should you experience any difficulty in running your KXL System, please contact your local Avedro-authorized representative.

## **Contraindications, Warnings and Cautions**

### **1.1.1 Contraindications**

This section describes situations in which the device should not be used because the risk of use clearly outweighs any possible benefit. Conditions that may contraindicate the use of the device include:

- Corneal thickness, with epithelium, of less than < 375 microns.
- Corneal melting disorders
- Aphakic patients
- Pseudophakic patients without UV blocking lens implanted
- Pregnant and nursing women
- Children

### **1.1.2 Warnings**

Physicians should evaluate the potential benefits in patients with the following conditions:

- Herpes simplex, herpes zoster keratitis, recurrent corneal erosion, corneal dystrophy
- Epithelial healing disorders
- In this manual, Caution is defined as: a statement that alerts the user to the possibility of a problem with the device associated with its use or misuse. Such problems include device malfunction, device failure, damage to the device or damage to other property. The caution statement includes the precaution that should be taken to avoid the hazard.
- In this manual, Warning is defined as: a statement that alerts the user to the possibility of injury, death, or other serious adverse reactions associated with the use or misuse of the device.

### **1.1.3 Electrical Safety Warnings**

This equipment requires special precautions regarding electromagnetic compatibility (EMC). Installation and use should be carried out according to the EMC information provided in this manual.



Portable and mobile RF communications equipment can affect medical electrical equipment such as the Avedro KXL System.

For Equipment Classifications, please refer to Chapter 5.0 Equipment Classifications.



**WARNING: WARNING: Any repair or service must be carried out by Avedro trained personnel only.**

**WARNING: Do NOT modify this equipment without authorization of the manufacturer.**



**WARNING: To avoid the risk of shock this equipment must only be connected to a supply mains with protective earth.**

**Even with the power cord removed, there is the potential for an electrical shock from the 12VDC internal power source.**

**The system is designed for continuous operation using the external connector or its internal rechargeable battery.**



**WARNING: This equipment is operated with hazardous voltages that can shock, burn, or cause death. To reduce the possibility of electrical shock, and inadvertent UVA exposure do not remove any fixed panels. Ensure that all service to the system, beyond what is described in this manual, including to the rechargeable battery, is performed only by qualified Avedro service personnel.**



**WARNING: Power down system and remove the wall plug and turn off the power switch before servicing or cleaning (disinfecting) the equipment.**

**Never pull cords to remove the power cord from the outlet. Grasp the power cord plug and pull it from the outlet to disconnect.**



**WARNING: Do not operate the equipment with a damaged power cord.**



**WARNING: Position the power cord so that it cannot be tripped over, walked on, rolled over, crimped, bent, pinched, or accidentally pulled from the wall outlet.**



**WARNING: Do not use the instrument near water and be careful not to spill liquids on any part of it.**



**WARNING: The USB port can only be used when the system is not in treatment mode, Do not connect to the USB during treatment.**



**WARNING: Do not operate the KXL System in the presence of flammable mixtures or anesthetics.**



**WARNING: Never look directly into the UV light beam. Never direct the beam towards a person except for therapeutic purposes.**



**WARNING: Ignoring local regulations on use of electro-optical medical devices may cause malfunction due to electromagnetic interference.**



**WARNING: The remote contains replaceable batteries; If system is not going to be used for an extended period of time, remove the batteries.**



**WARNING: Do not use adjacent to or stack with other equipment; if it is used adjacent to or stacked with other equipment, verify that the equipment behaves normally as intended.**



**WARNING: Use of not included accessories results in non-compliance of the device.**



**WARNING: System may be interfered with by other equipment even if that equipment complies with CISPR Emissions requirements. See Table 5-1.**



**WARNING: Portable RF communications equipment (including peripherals such as antenna cables and external antennas) should be used no closer than 30cm (12 inches) to any part of the Avedro KXL system, including cables specified by the manufacturer. Otherwise, degradation of the performance of this equipment could result.**



**WARNING: System shall not be serviced or maintained while in use with a patient.**



**WARNING: No modification of this equipment is allowed.**



**WARNING: Do not use a damaged or malfunctioning device. Use of such devices may harm the user and/or patient.**



**WARNING: MR Unsafe – Keep away from magnetic resonance imaging equipment.**

### 1.1.1 Radiation Safety Warnings



**WARNING: UV emitted from this product. Avoid eye and skin exposure to unshielded products. Never direct the beam towards a person except for therapeutic purposes.**



**WARNING: Always wear UVA protective goggles when the KXL system is turned on.**



**WARNING: Use only laser grade instruments in order to prevent reflected UV radiation from smooth metallic surfaces.**

### Patient Safety

The treatment should take place in a quiet atmosphere in order not to distract the attention of the patient.

- The patient should lie on a table or patient's chair.
- The patient's head should rest comfortably in a headrest. It is imperative that the table or patient's chair and the System not be moved during the treatment procedure.



**CAUTION: The KXL System is a medical device. It may be operated, therefore, only in health care facilities or medical areas under the supervision of medically trained personnel.**

### Additional Safety Considerations

- Any modification of the system's external light beam by means of optical elements is strictly prohibited.
- Plastic instrumentation such as speculums or eye shields may be damaged when impacted by the UV beam, possibly resulting in product degradation.  
Smooth metallic surfaces can reflect despite the effort to blank them. Therefore, only laser grade instruments should be used.

### FCC Compliance Notice

This equipment has been tested and found to comply with the limits for a Class B digital device, pursuant to Part 15 of the FCC Rules. These limits are designed to provide reasonable protection against harmful interference in a residential environment.

This equipment generates, uses, and can radiate radio frequency energy and, if not installed and used in accordance with the instruction manual, may cause harmful interference to radio communications. However, there is no guarantee that interference will not occur in a particular installation.

If this equipment does cause harmful interference to radio or television reception, which can be determined by turning the equipment off and on, the user is encouraged to try to correct the interference by one or more of the following measures:

- Reorient or relocate the receiving antenna.
- Increase the separation between the equipment and receiver.
- Connect the equipment into an electrical outlet on a circuit different from that to which the receiver is connected.
- Consult Avedro Customer Service for help.

Properly shielded and grounded cables and connectors must be used in order to meet FCC emission limits. Proper cables and connectors are available from Avedro. Avedro is not responsible for any radio or television interference caused by unauthorized changes or modifications to this equipment. Unauthorized changes or modifications could void the user's authority to operate the equipment.

## 2 Introduction

---

### System Overview

The KXL System is an electronic medical device which delivers ultraviolet light (365 nm wavelength) in a circular pattern onto the cornea after a solution of Riboflavin has been applied. Irradiating the Riboflavin creates singlet oxygen, which forms intermolecular bonds in corneal collagen. UV flux and irradiation time (that is, fluence) at the cornea are controlled by an onboard computer system.

The **Optics Head** houses the UVA irradiation mechanism. The LED is preset by the manufacturer to emit UVA radiation at a wavelength of 365 nm at an intensity of 3 mW/cm<sup>2</sup> to 45 mW/cm<sup>2</sup>.

A fixed aperture mounted in the UVA irradiation beam path is used to produce a circular area of irradiation at the treatment plane with a diameter of 9 mm. Alignment lasers are used to aid the user in focusing the beam on the patient's cornea. Fine alignment of the UV beam through observation of the alignment lasers is controlled by the user through a wireless remote. Treatment power is selectable by the user from 3 mW/cm<sup>2</sup> to 45 mW/cm<sup>2</sup> in 1 mW/cm<sup>2</sup> increments. Total Energy is selectable in 0.1 J increments on the user interface, but the actual limits are controlled by the RFID treatment card.

The KXL is a portable system with an articulating arm to allow movement of the system for alignment of the UV beam to the patient's cornea. An internal battery powers the system; the battery is recharged by a system internal charger from any standard AC outlet. The treatment parameters (Riboflavin Induction Period, Total UV Energy, UV Power, and UV Pulse Cycle Times) are selected through the user interface touchscreen computer.

The KXL System is used in conjunction with a Riboflavin solution and an RFID activation card.

**NOTE: The depictions of the KXL System and user interface screenshots included in this manual are for demonstration purposes only. Actual product may vary.**

### 2.1.1 Major Components

The major components of the KXL System include the following:

- Optics Head with UV source
- KXL console with user interface
- Wireless remote control (with replaceable batteries)
- KXL Accelerated Crosslinking Treatment Kit (disposable supplied separately)



**Figure 2-1. Overview Illustration of KXL System**

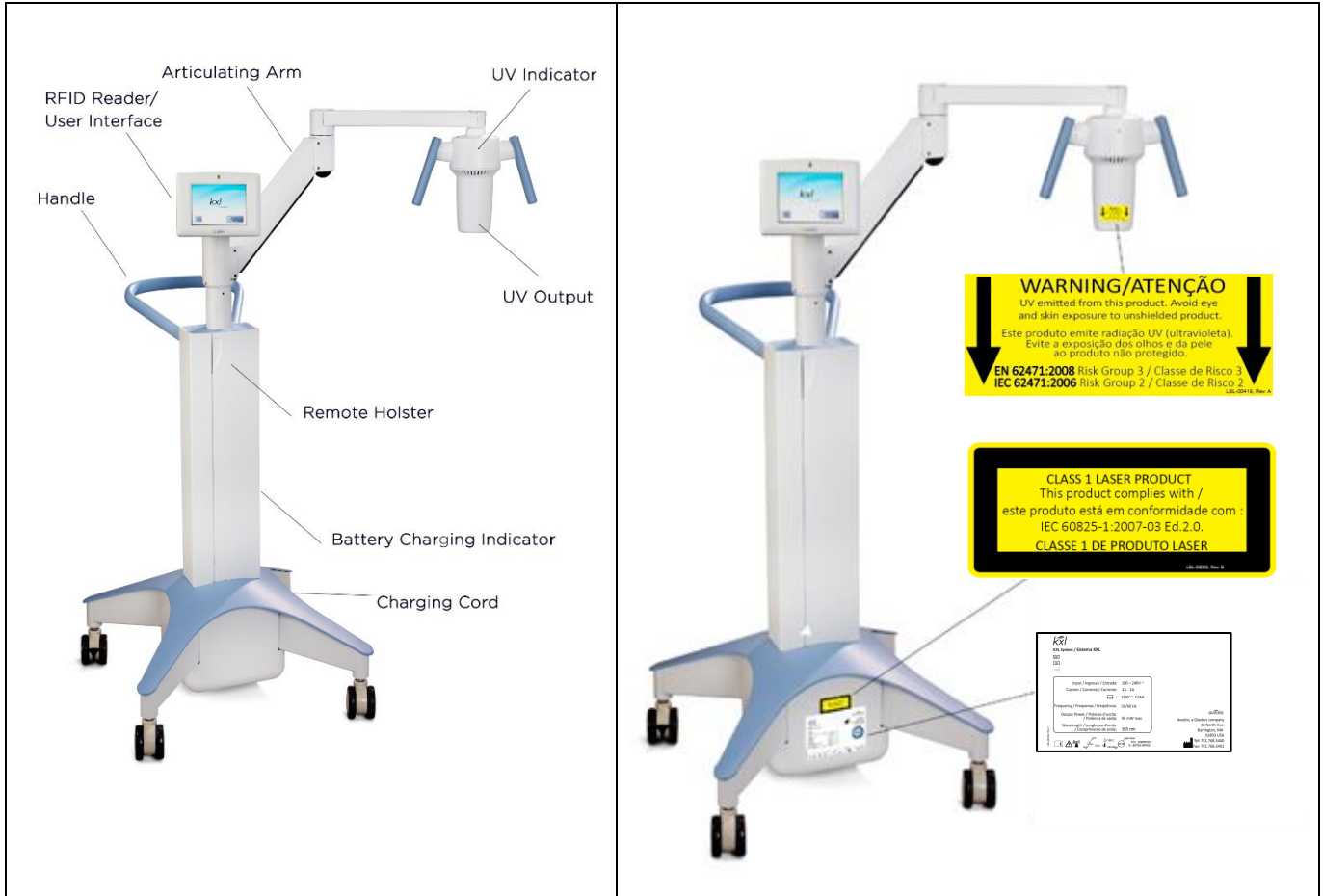


Figure 2-2. System Illustrations with Callouts



Figure 2-3. Wireless Remote



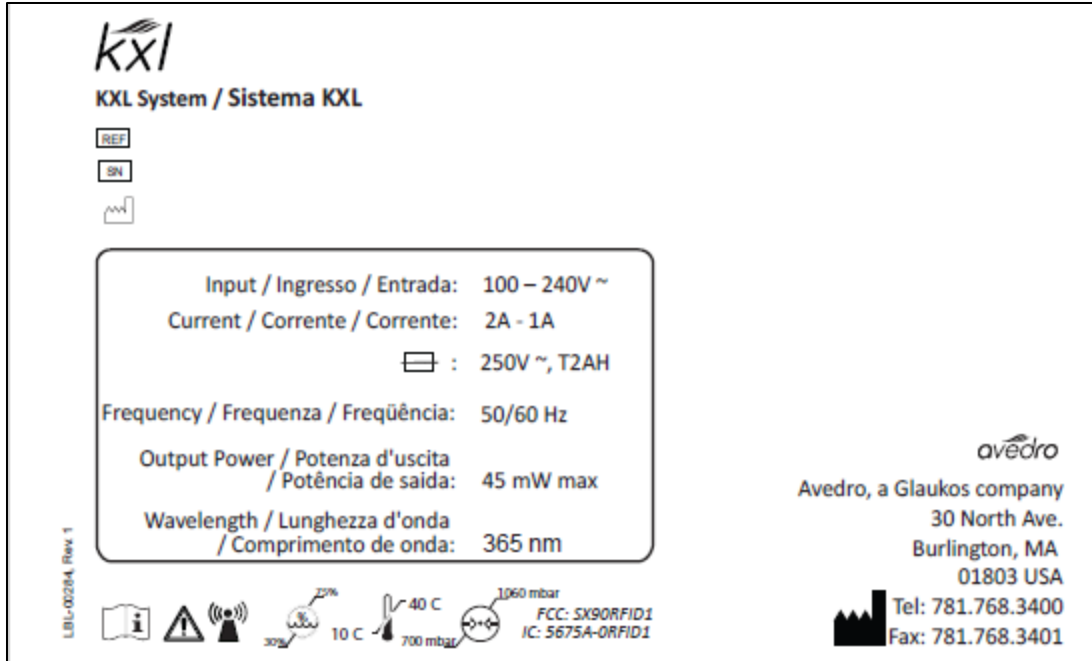


Figure 2-4. KXL Label



Figure 2-5. UV Emitting Label

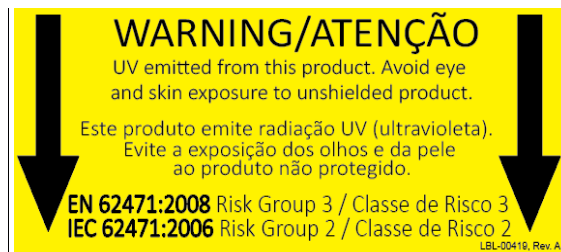


Figure 2-6. Alignment Laser Classification Label

## 3 System Operation

---

### Charging the KXL System Battery

**NOTE:** Prior to initial use, the internal battery pack of the KXL must be charged overnight.









- In order to maintain battery charge, it is recommended that the KXL be connected to a grounded mains supply at all times or at the end of each business day, including when not in use.
- The charging status of the battery is identified by the color of the light located on the column of the KXL.
  - Red/Orange: Low, charging
  - Yellow: Charging
  - Green: Fully charged
- The KXL battery should last for 16 hours during normal operation. The System software will notify the user when the battery needs to be charged.


**NOTE:** If the battery does not appear to be charging or retaining its charge, please contact your local Avedro Service Representative.

**NOTE:** The KXL System prohibits a treatment if there is insufficient battery power to perform a treatment. (See Chapter 4 Maintenance/Service for more information on troubleshooting battery problems.)

## Touchpad/Keyboard Use

The table below identifies and describes important touchpad keys and icons unique to KXL System operation. Chapter 2 identifies and describes the System’s major components.

Touchpad Key	Icon	Description/Function
Power Off button (Initial screen)		Turns OFF electric power to the internal computer.
Start New Treatment button (Initial screen)		Starts a new clinical treatment protocol.
UP arrow (various Clinical Protocol screens)		Increases the value of the current field.
DOWN arrow (various Clinical Protocol screens)		Decreases the value of the current field.
X button (various Device Settings screens)		Cancels all the entries on a particular screen and returns to the previous screen.
Checkmark button (various Clinical Protocol screens and Device Settings screen)		Directs the system to accept the current screen entries and to proceed to the next step.
Cancel Session button (various Clinical Protocol screens)		Cancels a treatment session for a particular patient. A prompt is then displayed to confirm your decision.
Return button (various Device Settings screen)		Returns to the Device Settings menu.

**KXL**  **CAUTION: Only qualified and experienced personnel shall operate the System.**

## UV Dose

- The UV Energy (Dose) is the product of the UV Power (Irradiance) and the UV Irradiation Time. The UV Energy and UV Power are adjustable and the calculated UV Irradiation Time is displayed.
- The System tracks UV Energy, UV Power, UV Irradiation Time and Total Treatment Time during the treatment.
- There are two UV treatment modes available, Continuous and Pulsed.

### 3.1.1 Continuous Mode

In Continuous Mode, UV output is constant for the duration of the UV treatment.

- Continuous Mode Parameters:
  - Induction Period: 1 second – 30 minutes
  - Wavelength: 365 nm
  - UV Energy: Controlled by the RFID card; User may select in 0.1 J increments
  - UV Power: 3 – 45 mW/cm<sup>2</sup>

### 3.1.2 Pulsed Mode

In Pulsed Mode, UV output turns ON and OFF at user selected intervals

- Pulsed Mode Parameters:
  - Induction Period: 1 second – 30 minutes
  - Wavelength: 365 nm
  - UV Energy: Controlled by the RFID card; User may select in 0.1 J increments
  - UV Power: 15 – 45 mW/cm<sup>2</sup>
  - UV ON Time: 1.0 – 4.0 seconds
  - UV OFF Time: 1.0 – 4.0 seconds

**Please reference Riboflavin Instructions for Use (IFU) for formulation information.**

## Preparing the System

- Position the KXL System adjacent to the treatment table or chair. Lock the casters to secure the device's position.

- Check glass window of beam aperture for dust and dirt. See Sections 4.8 and 4.9 for cleaning instructions.

### Important Steps Before Turning on the System

- The user is responsible for assuring that the KXL System is functioning properly and is in good working condition before starting a treatment.
- To ensure the System is functioning properly, consider the following mandatory points:
  - Inspect the device, accessories, and connecting cables for visible damage.
  - Take into consideration your local regulations for use of portable electro-optical medical devices.

### Powering Up the System

- Turn ON the single power switch on the front of the KXL console. This switch turns on all the system components.



*Figure 3-1. Power Switch*

- The KXL System begins a power-up sequence, loading the operating system and all configuration and reference files.
- Ensure that the System battery status indicator light is green.



Figure 3-2. Startup Screen

- To begin patient treatment, press the Start New Treatment button.
- Please see Section 3.17 for Power Down sequence instructions.

**NOTE: If there is a start-up error, please note any error messages and contact your distributor or Customer Service immediately.**

### Set Riboflavin Induction Period

- Specify the desired Riboflavin Induction Period (1 sec – 30 min).
- When finished entering parameters, press the Checkmark button.

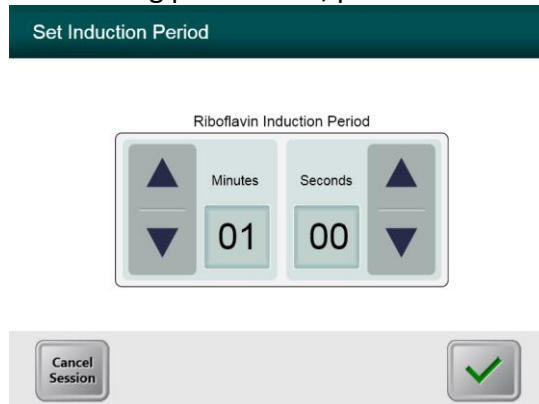


Figure 3-3. Induction Period Screen

**NOTE: Default treatment parameters will auto-populate user selectable fields but are adjustable. Defaults settings can be changed (see Section 3.19.6, Editing Default Treatment Parameters Screen).**

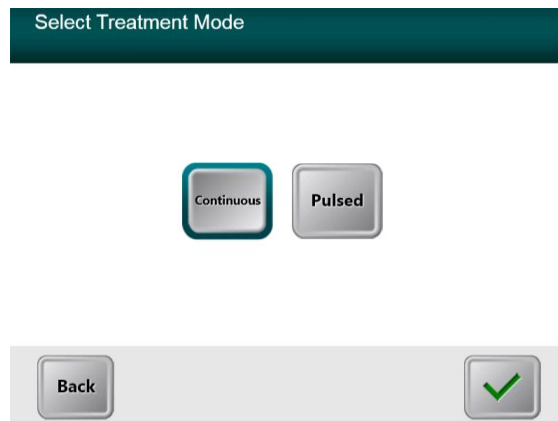
## Select UV Treatment Mode

There are two UV treatment modes available, Continuous and Pulsed.

- Continuous Mode: The UV output is constant for the duration of the UV treatment.
- Pulsed Mode: The UV output turns ON and OFF at user selected intervals.

### 3.1.3 Continuous UV Treatment Mode

- Select Continuous and press the Checkmark button.



*Figure 3-4. Select Continuous Treatment Mode Screen*

- Enter the desired UV treatment parameters:
  - Total Energy: User may select UV Energy in 0.1 J increments. Range is controlled by the RFID card
  - UV Power: 3 mW/cm<sup>2</sup> – 45 mW/cm<sup>2</sup>

**NOTE: UV irradiation time is displayed in the orange box.**

- When finished entering treatment parameters, press the Checkmark button.

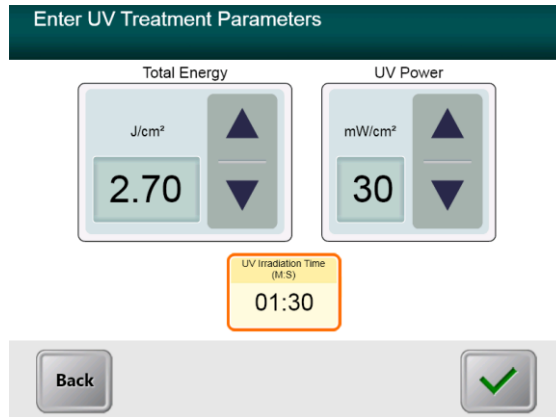


Figure 3-5. Continuous UV Treatment Parameters Screen

- Confirm the specified treatment parameters by pressing the Checkmark. If the treatment parameters are not correct, press the X and then re-enter the desired treatment parameters.

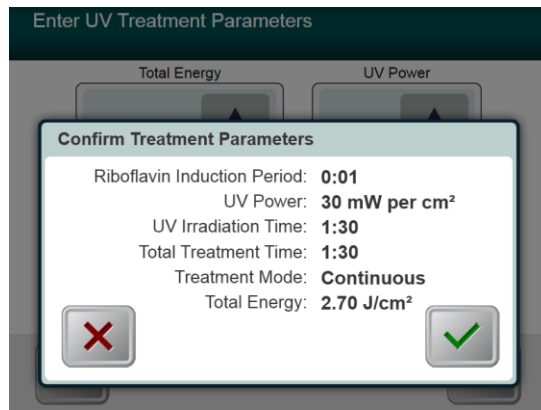


Figure 3-6. Confirm Continuous Treatment Parameters Screen

### 3.1.4 Pulsed UV Treatment Mode

- Select Pulsed and press the Checkmark button.

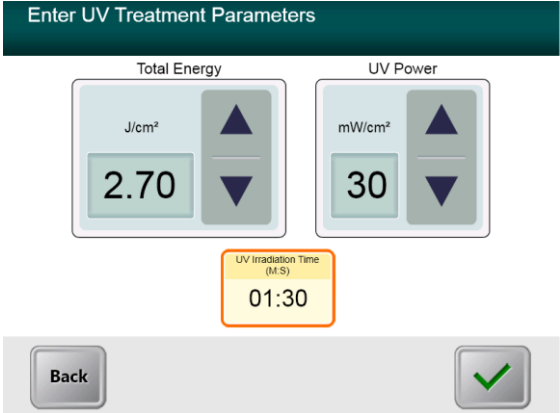


Figure 3-7. Select Continuous Treatment Mode Screen



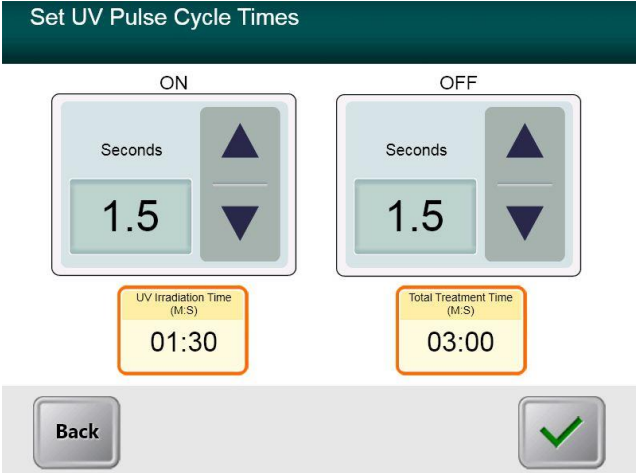
- Enter the desired UV treatment parameters:
  - Total Energy: User may select UV Energy in 0.1 J increments. Range is controlled by the RFID card.
  - UV Power: 15 mW/cm<sup>2</sup> – 45 mW/cm<sup>2</sup>

**NOTE: UV irradiation time is displayed in the orange box.**



**Figure 3-8. Pulsed UV Treatment Parameters Screen**

- When finished entering treatment parameters, press the Checkmark button.
- Select the desired times in which the UV is cycled ON and OFF.
- When finished entering treatment parameters, press the Checkmark button.



**Figure 3-9. Set Pulsed UV Cycle Times Screen**

- Confirm the specified treatment parameters by pressing the Checkmark. If the treatment parameters are not correct press the X and then re-enter the desired treatment parameters.

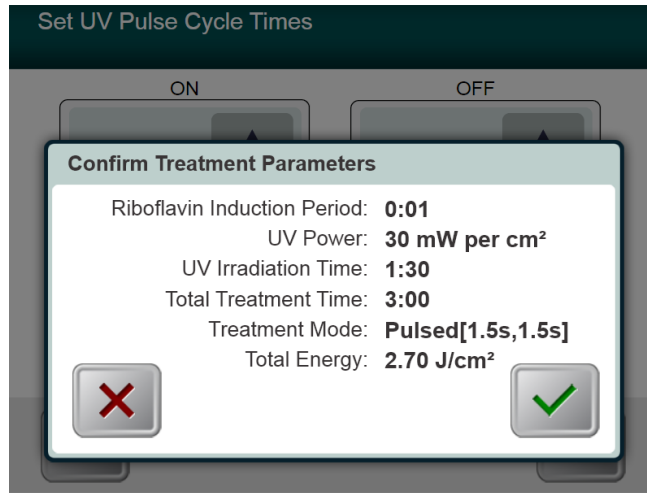


Figure 3-10. Confirm Pulsed UV Treatment Parameters Screen

### Starting Treatment

- Place the activation card on the RFID reader and hold in place until the system emits a beep.

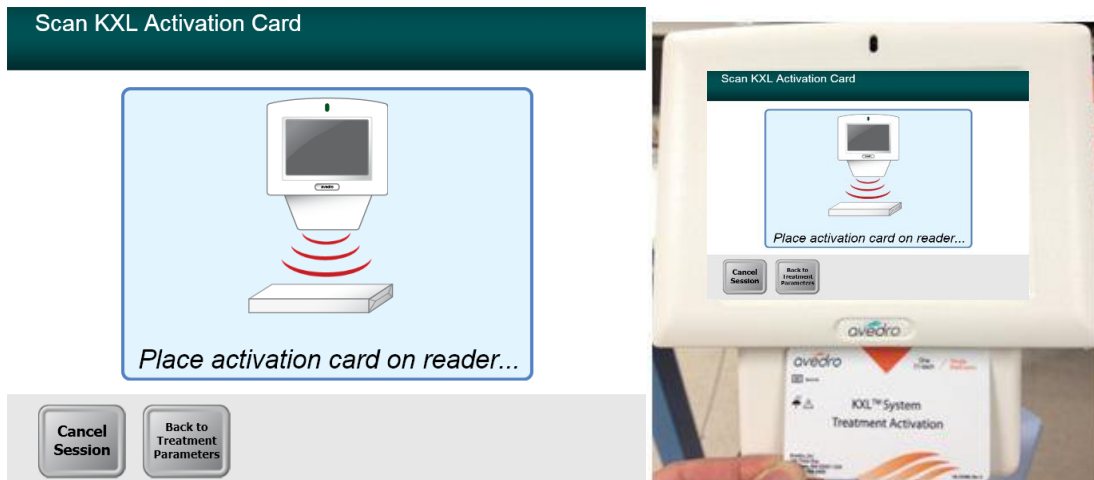


Figure 3-11. Reading Activation Card

### 3.1.5 Single-use Disposables

- Hold until read is complete and discard tag or activation card.

### 3.1.6 Multi-use Disposables

- Once a multi-use activation card has been scanned, the display will show the number of treatments remaining on the card.

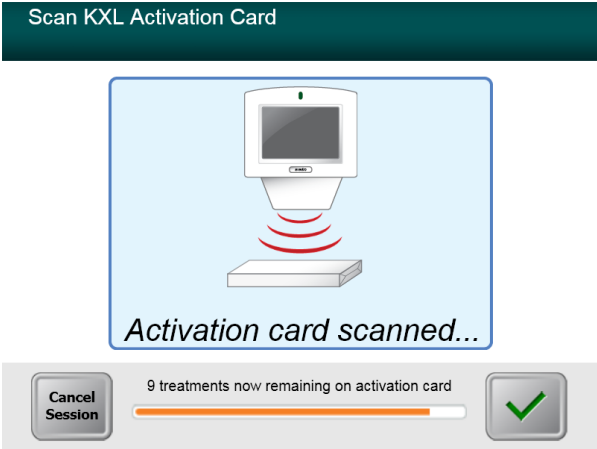


Figure 3-12. Treatments Remaining

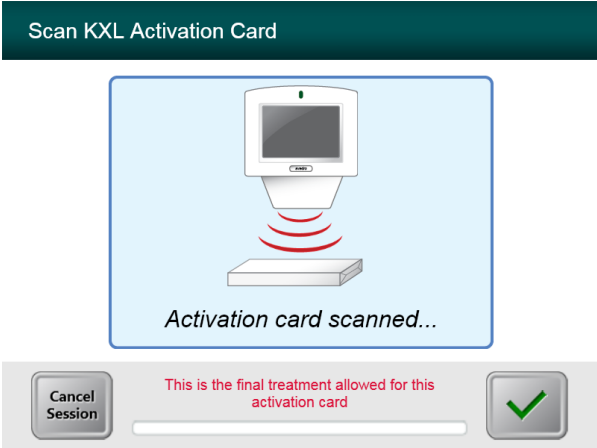
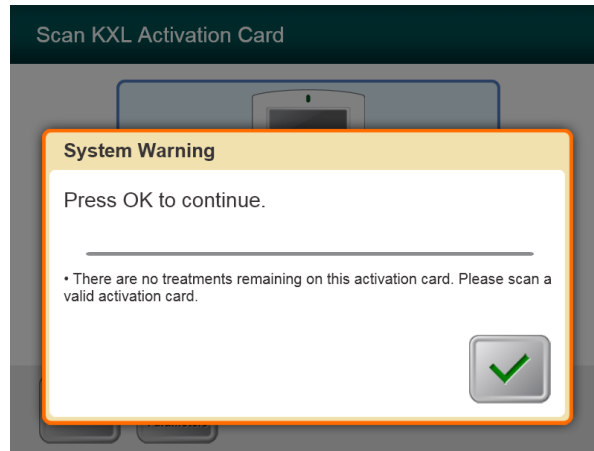


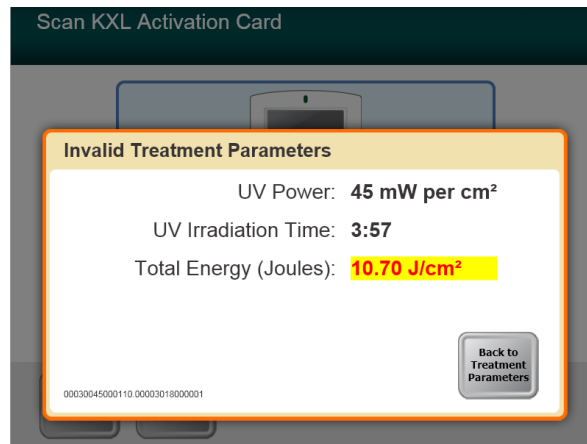
Figure 3-13. Final Treatment



**Figure 3-14. No Treatments Remaining**

### 3.1.7 RFID Card Controlled Limits

- If the user has previously programmed an UV Energy range that is outside the allowable value(s) controlled by the RFID card, an Invalid Treatment Parameters message will appear.

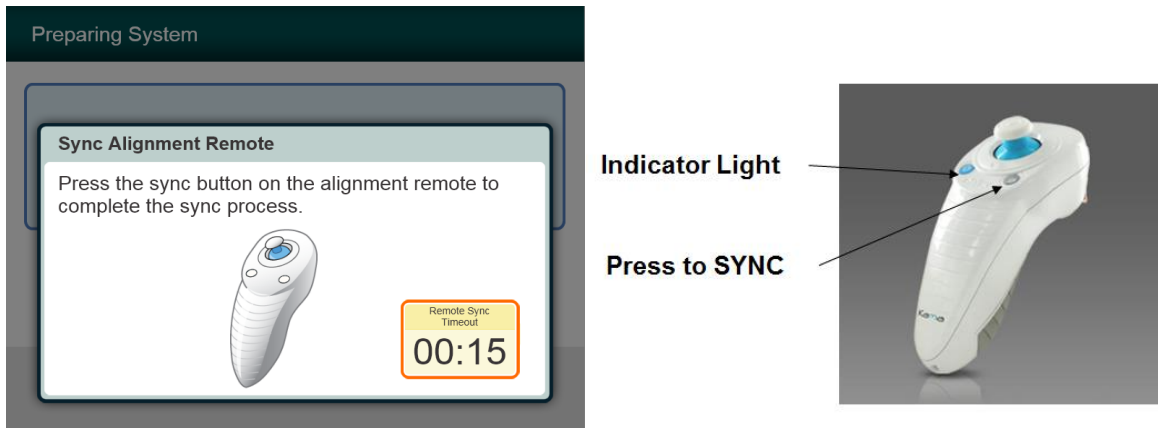


**Figure 3-15. Invalid Treatment Parameters**

- Press the Back to Treatment Parameters button to enter the appropriate parameter.

### 3.1.8 Sync Alignment Remote

- A Sync Alignment Remote window will appear before transitioning to the "Prepare for Treatment" window.
- Press the "S" button on the remote to synchronize the remote within the 15 second window displayed on the screen. This is required for every procedure.



**Figure 3-16. Remote Sync Status**

**Remote Indicator Light Status**

ON

Blinking once per second for 10 seconds

Blinking constantly, twice per second

**Meaning**

Actively synchronized with the device

Disconnection sync (after procedure)

Replace remote batteries immediately (2 AAA)

**NOTE: The KXL System performs an internal self-test prior to each treatment to verify proper UVA calibration.**

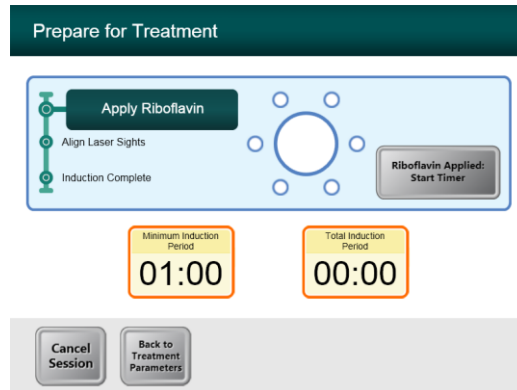
- The internal self-test uses a redundant set of optical sensors to ensure that accurate levels of UVA will be delivered for each treatment.
- If the internal self-test fails, an error message will be generated, and the treatment cannot proceed. If this occurs, contact your distributor or local Avedro technical service representative.
- Annual preventative maintenance of the KXL System is not required because the System performs an internal self-test prior to each eye being treated.

**Preparing the Patient**

- Ensure that the patient is lying flat or reclined on a patient table or chair. His or her head should rest in a headrest.
- Adjust the table or chair and headrest so that the patient can rest comfortably for the duration of the treatment without head movement.
- Apply a lid speculum and optional drapes using standard clinical technique.
- Apply Riboflavin to the area of treatment in accordance with the Riboflavin Instructions for Use (IFU).



**CAUTION: Riboflavin (vitamin B2) is not a part of the KXL System described in this manual. For details of component use, please refer to the component's Directions for Use.**



*Figure 3-17. Prepare Patient Screen*

**NOTE: Once the Riboflavin is applied to the eye, Start the induction by pressing the “Riboflavin Applied: Start Timer” button.**

### Alignment of the Device

- KXL has two alignment lasers.
  - Red crosshair for X and Y axis positioning.
  - A second red crosshair for Z axis positioning.
- Ensure that the alignment lasers are visible prior to performing a treatment.

**NOTE: For correct alignment when using the Remote, the Avedro logo on optics head should face the user**

- Manually move the Optics head back and forth and left and right until the red crosshairs are aligned to the center of the pupil.
- Manually move the Optics head up and down to align the Z axis or second red crosshair to the center of the first red crosshair.
- Fine tune the alignment as needed using the wireless remote.
- The patient should attempt to fixate on the red X & Y alignment crosshair throughout the treatment.

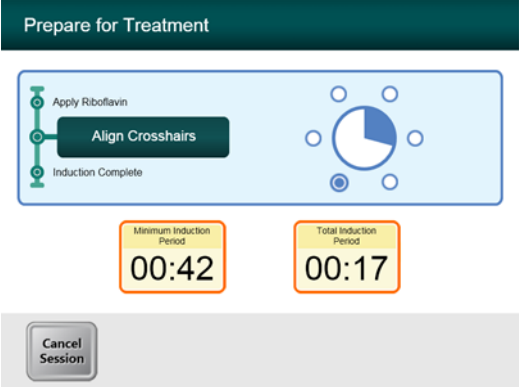


Figure 3-18. Align Crosshairs During Induction

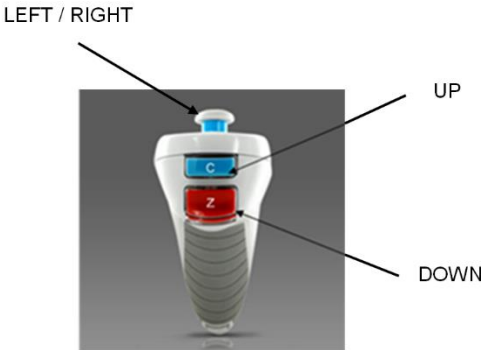


Figure 3-19. Remote Functions

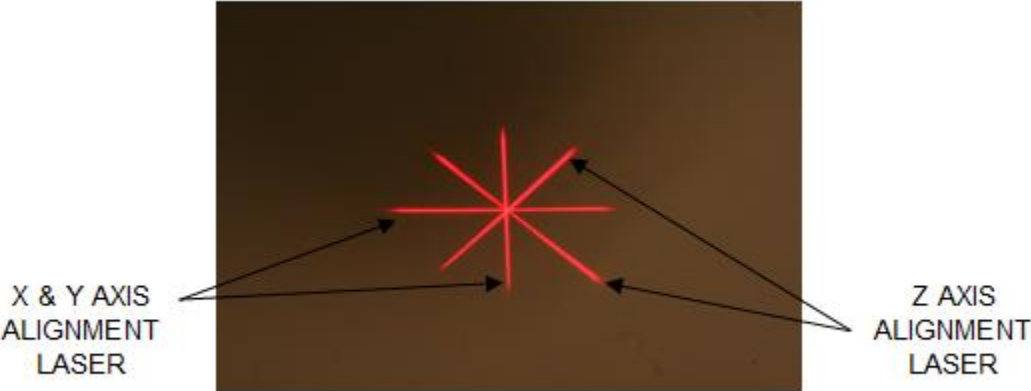


Figure 3-20. Red Crosshairs X & Y Axes, Red Crosshairs Z Axis Alignment

## Initiating Treatment

- Press the **“Begin UV Treatment”** button to initiate treatment.

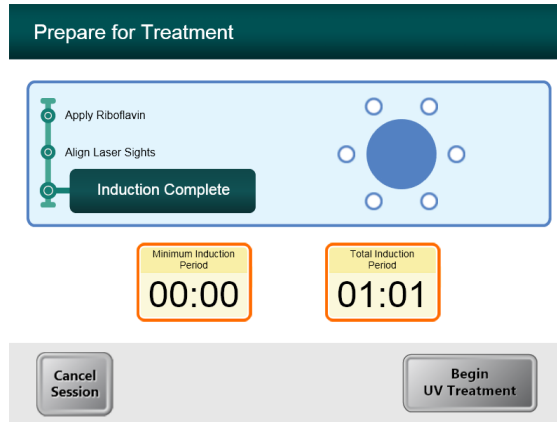


Figure 3-21. Induction Complete



**WARNING: Start treatments only after photosensitizer is applied.**



**WARNING: Make sure that the KXL System and the patient's table or chair are secured and not moved after alignment and during treatment.**



**CAUTION: UV light is emitted when the Avedro logo on the optical head changes color from blue to green.**

**NOTE: The KXL system continuously monitors UVA levels during treatment.**

- The internal monitor uses a redundant set of optical sensors to ensure that accurate levels of UVA are delivered throughout the treatment.
- If the UVA levels deviate from the intended values, an error message will be generated, and the treatment cannot proceed. If this occurs, contact your distributor or local Avedro sales representative immediately.

## Monitoring Treatment

- Check continuously that the area of interest on the cornea is illuminated with the UV light and adjust as necessary using the wireless remote.



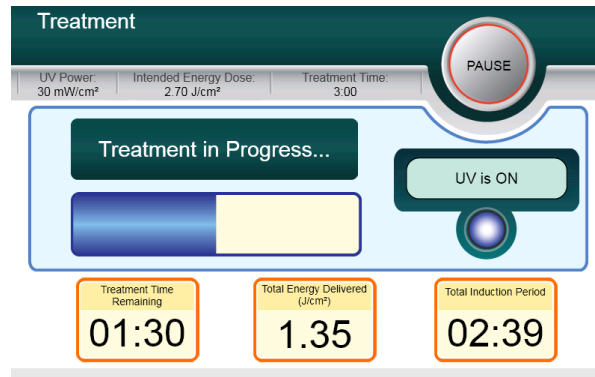


Figure 3-22. Treatment Screen

**NOTE: When using Pulsed Treatment mode, UVA light will not be visible during the OFF periods. The User Interface will not change to “UV is OFF” during these cycles.**

- The patient should attempt to fixate on the red X & Y alignment crosshair throughout the treatment.
- Patients should remain still during the treatment.

### Stopping a Treatment

- The treatment stops automatically after the user-programmed timer expires.
- The user may decide to stop or interrupt the treatment. In such case, the UV light can be switched OFF by pushing the **Pause** button.
- If treatment is **Paused**, the System will emit a double beep every few seconds as a reminder.

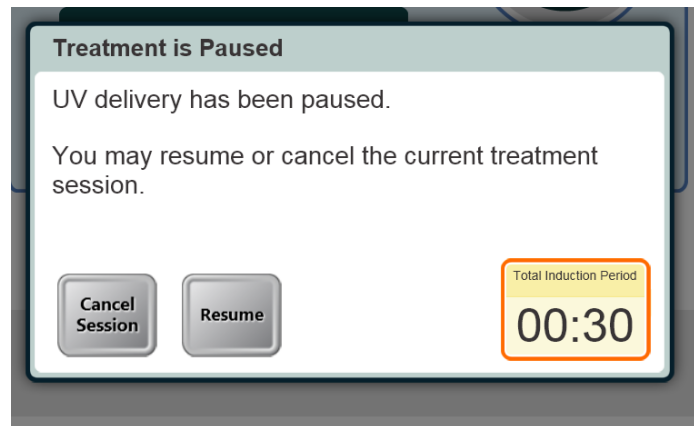
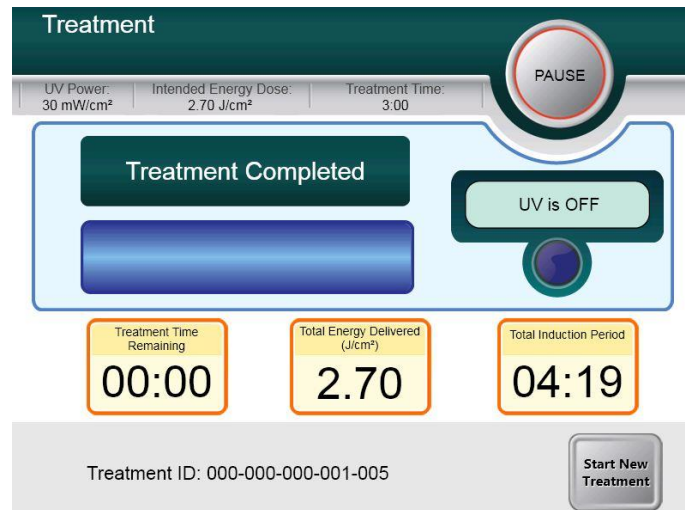


Figure 3-23. Treatment Paused Screen

- To cancel or resume treatment, press “Cancel Session” or “Resume” as appropriate. See Section 3.19 if canceling a session.

## Treatment Complete

- At the completion of a treatment, the Total Treatment Parameters will be displayed, and the screen will show "Treatment Completed."



**Figure 3-24. Treatment Complete Screen**

- Press "Start New Treatment" to exit treatment and / or start a new treatment.
- If treatments are complete, Power OFF the System using the "Power Off" button on the Main Screen.
- Carefully remove the device from the patient area.
- Apply antibiotic ointment on the cornea and then cover cornea with a bandage contact lens.
- Remove speculum.
- Give post-op medication using a regimen similar to after photorefractive keratectomy (PRK): pain medication, steroids, antibiotics.

## Pausing or Canceling a Treatment

Treatment may be paused at the discretion of the user. If a session is **anceled**, the screen displays with “**Confirm Cancel Session.**”

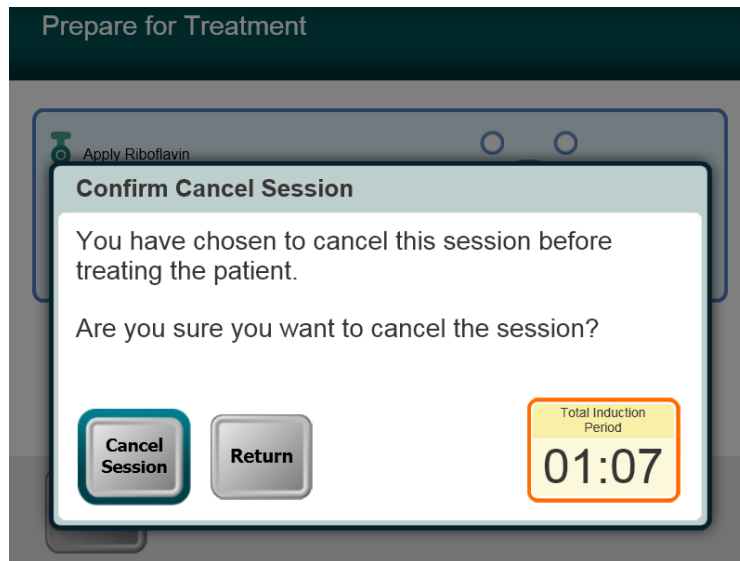


Figure 3-25. Confirm Cancel Session Screen

- To cancel a session, press “**Cancel Session.**”
- If the session is **Paused**, the screen displays “**Confirm Cancel Partial Treatment.**”

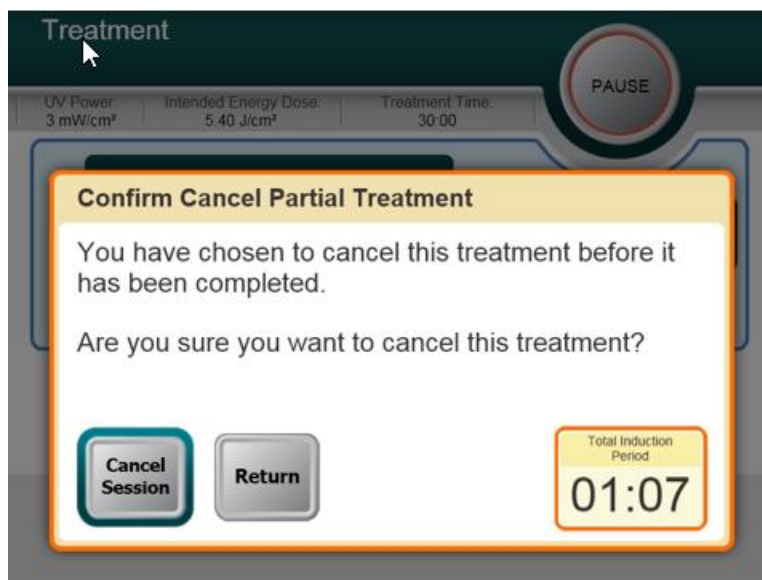
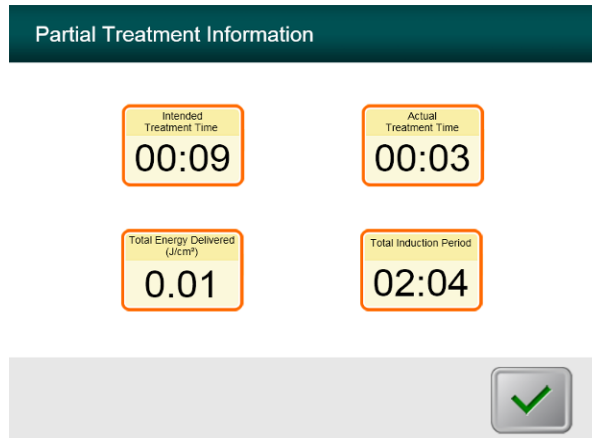


Figure 3-26. Confirm Cancel Partial Treatment

- To cancel the session, press “**Cancel Session.**”

- The screen displays “**Partial Treatment Information.**”



*Figure 3-27. Partial Treatment Information*

## Powering Down the System

**NOTE:** It is recommended that the KXL System be plugged into an electrical outlet when not in use or when stored.



*Figure 3-28. Power Off*

- Press the “Power Off” on the touch screen monitor.
- Wait for the software to shut down - the screen will be blank.



*Figure 3-29. Power Off Position*

- Turn the system power switch to the “Off” position.



**Figure 3-30. KXL System Plug**

- If the KXL System is not already plugged in, plug the KXL System into an AC outlet until next use.

### Checking KXL System Battery Function after Storage

If the KXL System has not been plugged into an AC outlet or in use for a period of 3 months or more, proceed as follows to determine the health of the KXL System battery.

- With the System fully powered down, plug the System into an AC outlet for at least 8 hours.
- After at least 8 hours of charging, observe the charge indicator LED light on the side of the device main body.
- If the indicator is green, the battery is healthy, and the System can be used as normal.



**Figure 3-31. KXL System Battery Status Indicator**

- If the indicator is not green (yellow or orange/red), the battery may be damaged. Do not use the System to treat patients. Contact your Avedro sales representation or Customer Service.

## Using the Device Settings Menu

- With the Initialization screen (Start New Patient) displayed, press and hold the KXL logo on the touchscreen.

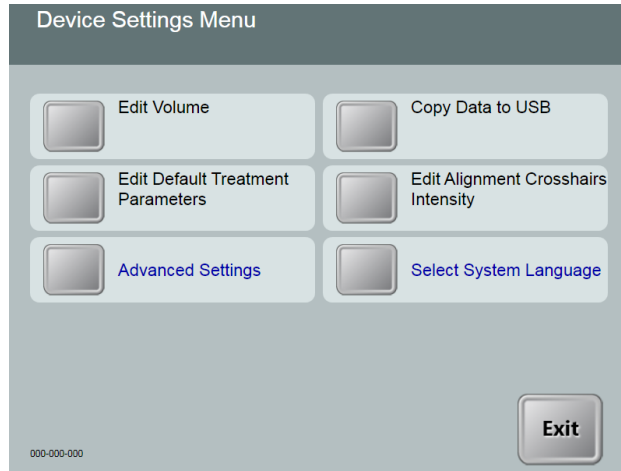


Figure 3-32. Device Settings Menu

### 3.1.9 Advanced Settings

- Advanced Settings are only available to Avedro and Service personnel with a KXL Advanced Settings access card. If selected, the user will be prompted to scan an access card.

### 3.1.10 Editing System Language

- The System Language option allows a user to select the language of the Graphical User Interface.
- Select the desired language from the dropdown menu.

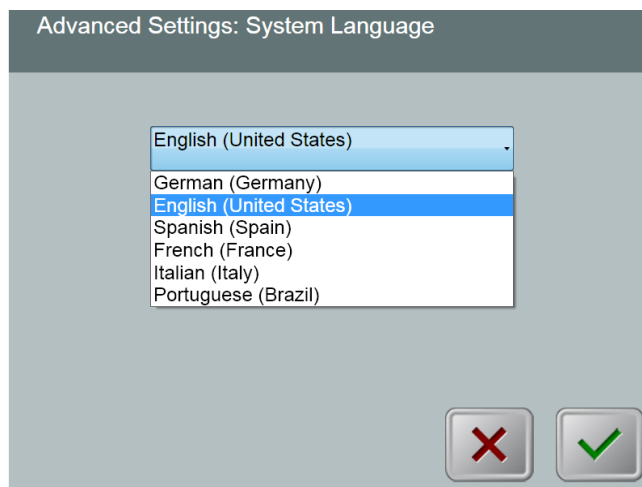
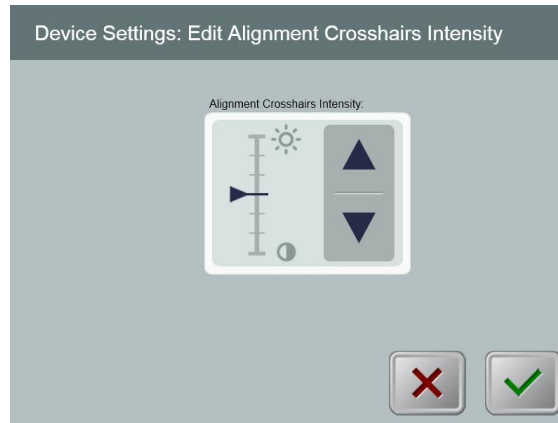


Figure 3-33. Edit System Language

### 3.1.11 Editing Alignment Crosshairs Intensity

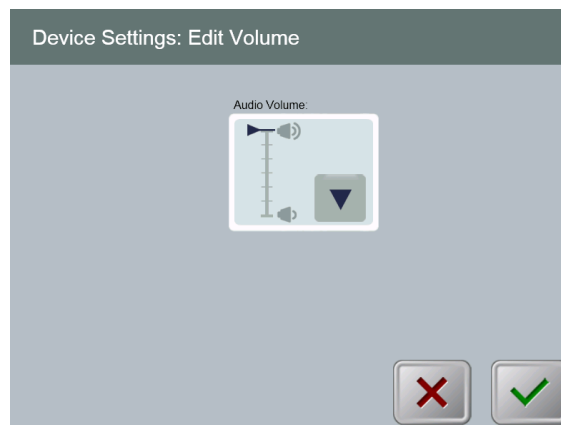
- The Alignment Crosshairs Intensity option allows a user to edit the brightness of the alignment crosshairs.
- Select the **Edit Alignment Crosshairs Intensity** button on the Device Settings menu.



*Figure 3-34. Edit Alignment Crosshairs Intensity*

### 3.1.12 Editing System Volume

- The Edit Volume option allows a user with the appropriate security level to edit the system volume level.
- Select the **Edit Volume** button on the Device Settings menu.



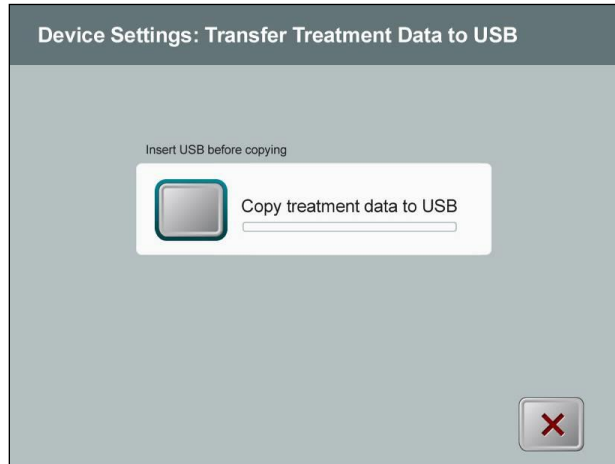
*Figure 3-35. Edit Volume*

### 3.1.13 Copying Treatment Data to USB



**WARNING:** The USB port can only be used when the system is not in treatment mode. Do not have items connected to the USB during treatment.

- Select the **Copy Treatment Data to USB** button on the Device Settings menu.



*Figure 3-36. Data Transfer to USB*

- Insert a USB device to a USB port and then press the **Copy treatment data to USB** button. The System begins transferring the treatment data and shows a progress bar of the transfer process as shown in the screen below.
- Once complete press the **Return** button. The System will return you to the Device Settings menu.



### 3.1.14 Editing Default Treatment Parameters

- The Edit Default Treatment Parameters option allows a user to set the default treatment parameters that are displayed on entry to the Set Induction Time and Set UV Parameters screens.



Figure 3-37. Edit Default UV Treatment Mode Parameters

- Press the Checkmark button to continue.

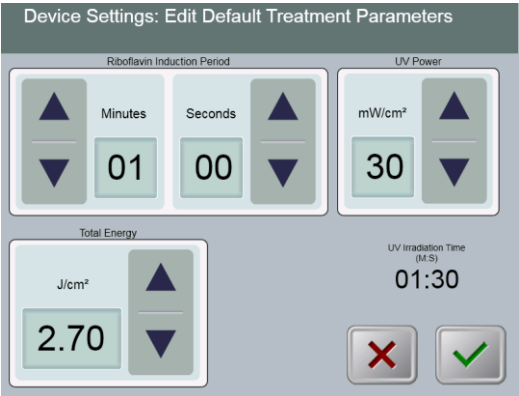


Figure 3-38. Edit Default Treatment Parameters (Continuous & Pulsed)

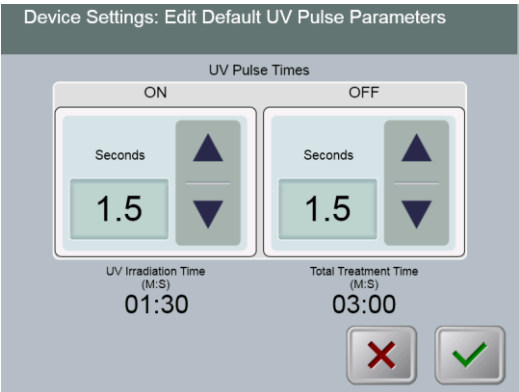


Figure 3-39. Edit Default UV Pulse Parameters (Pulsed Only)

- When treatment parameters are confirmed, press the **Checkmark** button to exit these Settings.

## 4 Maintenance / Service

---

By definition, “maintenance” refers to those non-technical procedures an everyday operator must perform to keep the system working properly. The word “service,” by contrast, refers to tasks that are intended to be performed only by a qualified service representative.

### Installation Policy

- For each new KXL System, your Avedro-authorized distributor provides a full initial installation and start-up of the System. Following initial installation and once the System is operating properly, the Avedro representative may also provide basic training to a designated operator about the basic operation of the KXL System.
- Consequently, this manual does not include any specific instructions relating to installation or set-up of the System. Per your service agreement, any further hardware adjustment, other than what is specified for normal operation, should be performed by, or with the guidance of, an Avedro-authorized distributor.

### Customer Maintenance

- In general, there is no customer maintenance required for the KXL System. All technical maintenance or service will be performed by a qualified service representative while under service contract. If you have trouble with your system, refer to the troubleshooting section below or call your local Avedro Representative.

### Warranty Information

- A Warranty is supplied separately with the purchasing information.

### Service Contract Information

- A service contract is available on all KXL Systems. The contract provides for regularly scheduled maintenance. It also provides for any non-scheduled service calls that may be necessary.

## Per Patient Disposables

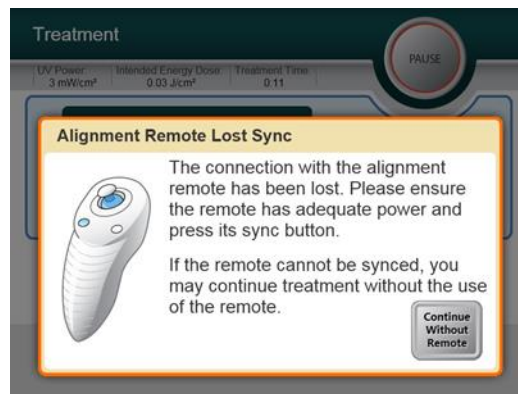
- Per Patient Disposables can be ordered from Avedro or your Avedro-authorized distributor. **Use only Avedro products or Avedro-approved products with your KXL System.** Avedro shall not be liable for damage to or malfunction of the system, which it deems, was caused by the use of unauthorized materials.

## Troubleshooting

- The KXL System checks its status at start-up automatically. If the status is incorrect, the software prevents the operator from initiating treatments when the System is in normal operating state.

### 4.1.1 Wireless Remote

- The KXL System uses a remote control with replaceable batteries. If the batteries run low, the system will lose its connection with the remote and notify the user of the need to re-synchronize. The user will not be able to initiate a procedure.
- If the remote synchronization is lost during a treatment, the user will be prompted to determine if they want to continue the treatment without the remote.



**Figure 4-1. Alignment Remote Lost Sync**

- If light on the remote is flashing two times per second, the remote's batteries need to be changed. If the light on the remote is flashing once per second, then it is not synchronized.
- If the remote does not re-synchronize by pressing the "Sync" button, replace the batteries.
- If replacing the batteries does not allow the System to synchronize, contact your local Avedro Service Representative.

### 4.1.2 Internal Rechargeable Battery

- The KXL System is supplied with a rechargeable battery, if the system does not appear to be turning on, ensure that the battery is charged by plugging it into an outlet and checking the charging indicator on the column of the system. If the light is orange or yellow, the system is charging. If it is green, it is fully charged.
  - If the indicator is green or yellow and the system still does not turn on, contact your local Avedro service representative.
  - If the indicator is red/orange, wait until it turns yellow or green and try turning the system on. If it still does not turn on or the indicator does not go yellow or green after charging for at least 8 hours, contact your local Avedro service representative.

### Directions for Sterilization or Disinfection

- No components of the KXL System are designed to be sterilized by the operator. External cleaning and disinfection **ONLY** is recommended. For disinfection purposes, use only isopropyl alcohol spray or preparations. Use small amounts of liquid and soft fiber-free wipes.

### Cleaning the System



**CAUTION: Remove the power supply cord from the main outlet and turn off the power switch prior to any cleaning procedure.**



**CAUTION: Aggressive cleaning agents, especially those containing abrasives or aggressive solvents can damage component surfaces.**

- Use a soft damp cloth to clean the system.
- The exterior of the KXL System can be cleaned using a lint-free cloth dampened with isopropyl alcohol.
- DO NOT submerge the system in liquid or pour liquid onto the system.
- While cleaning the surfaces of the device, ensure that cleaning fluids do not seep inside the device, as this leakage can damage the device.
- Use a lint-free cloth dampened with isopropyl alcohol to clean the remote control.

### Cleaning the Aperture



**CAUTION: The glass window of the beam aperture must not under any circumstances be in contact with any aggressive cleaning agents.**

- Check the beam aperture routinely prior to treatment.
- Use special camera lens wipes or compressed air to remove dust and particles from the glass surface of the aperture.

### Articulating Arm Adjustment

If the articulating arm does not hold the Optical Head in a fixed vertical position, follow the steps outlined below to counterbalance the articulating arm.

- Press the arm down to approximately parallel to the floor.

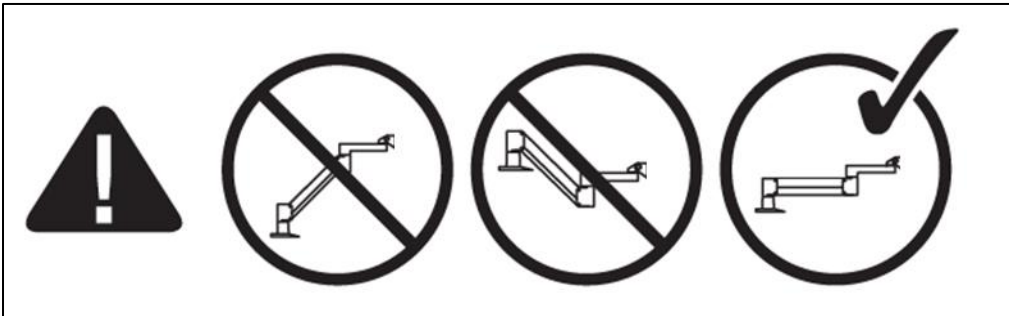




Figure 4-2. Position the Arm Parallel to the Floor

- If the arm **drifts upward**, turn the adjustment screw clockwise using a 7/32" Allen Wrench. See Figure 4-2. 
- If the arm **drifts downward**, turn the adjustment screw counterclockwise using a 7/31" Allen Wrench. See Figure 4-2. 

**NOTE: 15-20 turns may be needed.**

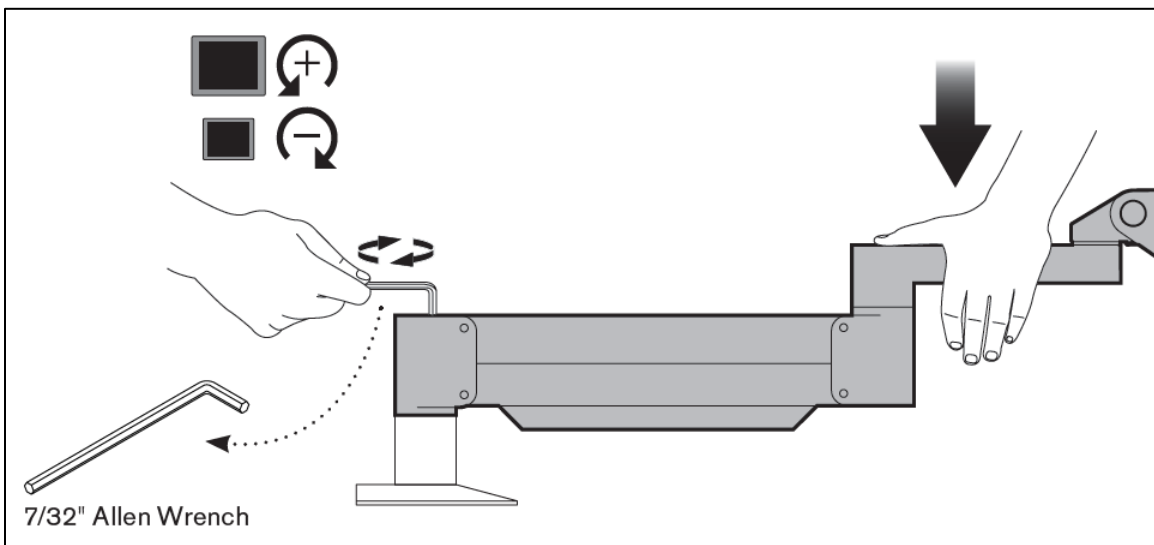


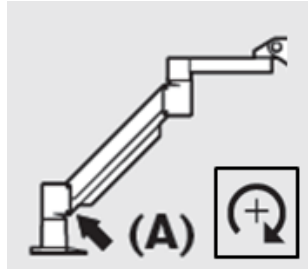
Figure 4-3. Turn the Adjustment Screw

**In some instances**, further counterbalance adjustments are needed to allow the arm's instant height adjustment function to work properly.

If your arm is not staying in position after performing the above steps, perform the following steps:

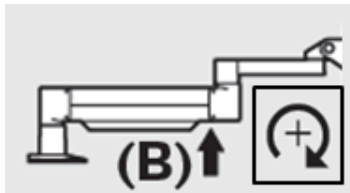
**NOTE: Do not over tighten screws.**

- With arm in a raised position, tighten set screw **(A)** with a 3/32" Allen Wrench.

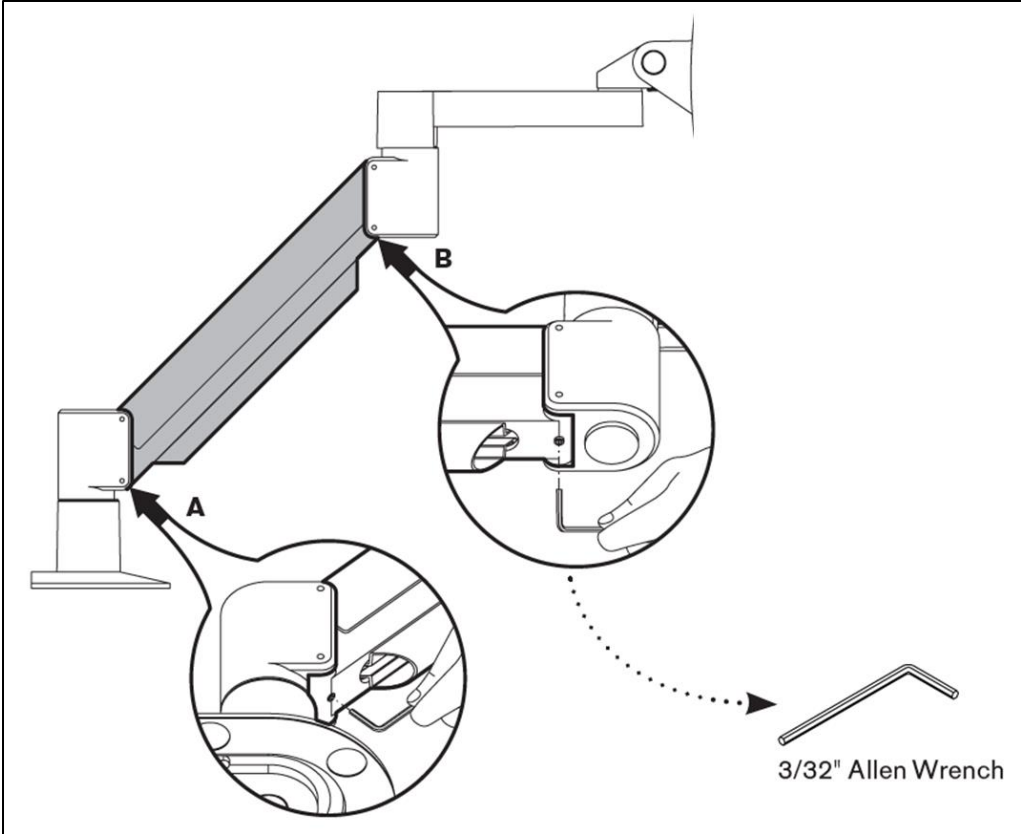


*Figure 4-4. With Arm Raised, Tighten Set Screw (A)*

- With arm in a horizontal position, tighten set screw **(B)** with a 3/32" Allen Wrench.



*Figure 4-5. With Arm Horizontal, Tighten Set Screw (B)*

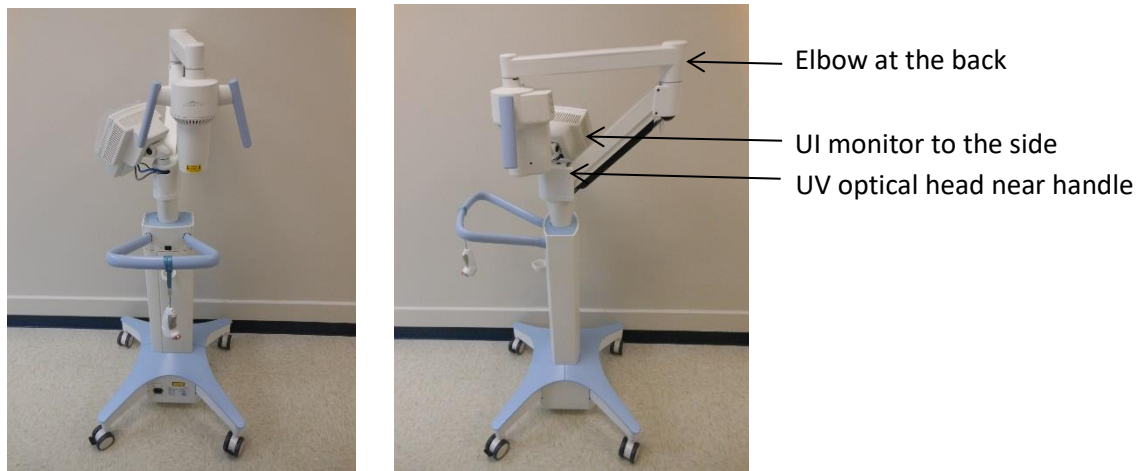


**Figure 4-6. Summary of Further Counterbalance Adjustments**

- If you continue to have issues with the articulating arm after following the above steps, contact your local Avedro service representative.

## Moving the System

- The KXL is designed as a movable system within an office environment. If it ever proves necessary to transport or ship the KXL System, for any reason, contact your local Avedro representative. Packing and transporting the system should be performed only by Avedro trained and authorized personnel.
- Prior to moving the KXL System from one room to another, the monitor should be moved sideways and the optics head should be positioned close to the cart handle with the elbow protruding at the back. The system can then be easily pushed by the cart handle through the door frame.



**Figure 4-7. Moving System Configuration**

## Storing the System

- Follow all the storage temperature and humidity range specifications as listed in the Specifications, Section 7.
- Close all panels on the system to prevent dust and moisture from entering; this is mandatory.
- Turn OFF all the components and the main power supply as well. It is recommended that the System remain plugged into an electrical outlet if not being used for more than 3 months.
- Remove the batteries from the wireless remote.
- Cover the touch screen LCD display and keyboard with its original cover or packaging to prevent any damage.
- Do not disassemble any part of the system as this could cause misalignment or damage.



## **Software**

- Should the software become corrupted and fail to work correctly at some point, call your local Avedro service representative. Software updates will only be carried out by Avedro service representatives.

## **Identifying Risks Associated with Disposing of Waste Products**

- When disposing of waste products, follow all applicable local regulations.

## **Performing a Visible Check**

- Check all components of the System routinely for damage or malfunction prior to each treatment.
- Do not use a damaged or malfunctioning System. Use of such a System may harm the user and/or patient.

# 5 Equipment Classification

---

## Equipment Classification

According to IEC60601-1 Medical Device Electrical Standard

- Protection against electrical shock
  - Class 1 (external electrical power source)
  - Internally powered equipment (internal battery operation)
- Degree of protection against electric shock
  - Not classified, equipment not provided with applied part
  - Ingress protection: IP20
- Method of sterilization or disinfection
  - Disinfectable device
- Degree of protection for use in the presence of a flammable anesthetic mixture
  - No protection
- Use conditions
  - Continuous service

According to FCC Part 15, IEC55011 and IEC60601-1-2

- Class B

According to IEC60825-1 Safety of laser productions

- Alignment lasers are Class 1 Laser Product

According to IEC62471 Photobiological safety of lamps and lamp systems

- UVA LED is Risk Group 1

**EMC Guidance**




The KXL System requires special precautions regarding electromagnetic compatibility (EMC). Installation and use should be carried out according to the EMC information provided in this manual. Portable and mobile RF communications equipment may affect the KXL System.

Guidance and manufacturer’s declaration - electromagnetic emissions		
The KXL UV Illumination System is intended for use in the electromagnetic environment specified below. The customer or the user of the KXL UV Illumination System should assure that it is used in such an environment.		
Emissions test	Compliance	Electromagnetic environment — guidance
RF emissions CISPR 11	Group 1	The KXL UV Illumination System uses RF energy only for its internal function. Therefore, its RF emissions are very low and are not likely to cause any interference in nearby electronic equipment.
RF emissions CISPR 11	Class B	The KXL UV Illumination System is suitable for use in all establishments other than domestic, and may be used in domestic establishments and those directly connected to the public low-voltage power supply network that supplies buildings used for domestic purposes, provided the following warning is heeded:  <b>Warning:</b> This equipment/system is intended for use by healthcare professionals only. This equipment/system may cause radio interference or may disrupt the operation of nearby equipment. It may be necessary to take mitigation measures, such as re-orienting or relocating the KXL UV Illumination System or shielding the location.
Harmonic emissions IEC 61000-3-2	Class A	
Voltage fluctuations/ flicker emissions IEC 61000-3-3	Complies	

*Table 5-1. Electromagnetic Emissions*

<b>Guidance and manufacturer's declaration — electromagnetic immunity</b>			
The KXL UV Illumination System is intended for use in the electromagnetic environment specified below. The customer or the user of the KXL UV Illumination System should assure that it is used in such an environment.			
<b>Immunity test</b>	<b>IEC 60601 test level</b>	<b>Compliance level</b>	<b>Electromagnetic environment - guidance</b>
Electrostatic discharge (ESD) IEC 61000-4-2	±6 kV contact ±8 kV air	±6 kV contact ±8 kV air	Floors should be wood, concrete or ceramic tile. If floors are covered with synthetic material, the relative humidity should be at least 30%.
Electrical fast transient/burst IEC 61000-4-4	±2 kV for power supply lines ±1 kV for input/output lines	±2 kV for power supply lines Not Applicable Input /Output Lines	Mains power quality should be that of a typical commercial or hospital environment.
Surge IEC 61000-4-5	±1 kV line(s) to line(s) ±2 kV line(s) to earth	±1 kV line(s) to line(s) ±2 kV line(s) to earth	Mains power quality should be that of a typical commercial or hospital environment.
Voltage dips, short interruptions and voltage variations on power supply input lines IEC 61000-4-11	<5 % $U_T$ (>95 % dip in $U_T$ ) for 0.5 cycle 40% $U_T$ (60% dip in $U_T$ ) for 5 cycles 70% $U_T$ (30% dip in $U_T$ ) for 25 cycles <5% $U_T$ (>95 % dip in $U_T$ ) for 5 sec	0% $U_T$ for 0.5 cycles  40% $U_T$ for 5 cycles  70% $U_T$ for 25/30 cycles  0% $U_T$ for 250/300 cycles	Mains power quality should be that of a typical commercial or hospital environment, If the user of the KXL UV Illumination System requires continued operation during power mains interruptions, it is recommended that the KXL UV Illumination System be powered from an uninterruptible power supply or a battery.
Power frequency  (50/60 Hz) magnetic field  IEC 61000-4-8	3 A/m	3 A/m	Power frequency magnetic fields should be at levels characteristic of a typical location in a typical commercial or hospital environment.
NOTE $U_T$ is the a.c. mains voltage prior to application of the test level.			

**Table 5-2. Electromagnetic Immunity**

<b>Guidance and manufacturer’s declaration – electromagnetic immunity</b>			
The KXL UV Illumination System is intended for use in the electromagnetic environment specified below. The customer or the user of the KXL UV Illumination System should assure that it is used in such an environment.			
<b>Immunity test</b>	<b>IEC 60601 test level</b>	<b>Compliance level</b>	<b>Electromagnetic environment — guidance</b>
Conducted RF IEC61000-4-6	3 Vrms 150 kHz to 80 MHz	3 Vrms	Portable and mobile RF communications equipment should be used no closer to any part of the KXL UV Illumination System, including cables, than the recommended separation distance calculated from the equation applicable to the frequency of the transmitter. <b>Recommended separation distance</b> $d = 1.2\sqrt{P}$
Radiated RF IEC 61000-4-3	3 V/m 80 MHz to 2.5 GHz	3 V/m	$d = 1.2\sqrt{P}$ 80 MHz to 800 MHz $d = 2.3\sqrt{P}$ 80 MHz to 2.5 GHz
<b>Immunity test</b>	<b>IEC 60601 test level</b>	<b>Compliance level</b>	<b>Electromagnetic environment — guidance</b>  where $P$ is the maximum output power rating of the transmitter in watts (W) according to the transmitter manufacturer and $d$ is the recommended separation distance in meters (m). Field strengths from fixed RF transmitters, as determined by an electromagnetic site survey, <sup>a</sup> should be less than the compliance level in each frequency range. <sup>b</sup> Interference may occur in the vicinity of equipment marked with the following symbol:  
NOTE 1 At 80 MHz and 800 MHz, the higher frequency range applies.			
NOTE 2 These guidelines may not apply in all situations. Electromagnetic propagation is affected by absorption and reflection from structures, objects and people.			
a Field strengths from fixed transmitters, such as base stations for radio (cellular/cordless) telephones and land mobile radios, amateur radio, AM and FM radio broadcast and TV broadcast cannot be predicted theoretically with accuracy. To assess the electromagnetic environment due to fixed RF transmitters, an electromagnetic site survey should be considered. If the measured field strength in the location in which the KXL UV Illumination System is used exceeds the applicable RF compliance level above, the KXL UV Illumination System should be observed to verify normal operation. If abnormal performance is observed, additional measures may be necessary, such as re-orienting or relocating the KXL UV Illumination System.			
b Over the frequency range 150 kHz to 80 MHz, field strengths should be less than 3 V/m.			

**Table 5-3. Electromagnetic Immunity (continued)**

<b>Recommended separation distances between portable and mobile RF communications equipment and the KXL UV Illumination System</b>			
The KXL System is intended for use in an electromagnetic environment in which radiated RF disturbances are controlled. The customer or the user of the KXL System can help prevent electromagnetic interference by maintaining a minimum distance between portable and mobile RF communications equipment (transmitters) and the KXL UV Illumination System as recommended below, according to the maximum output power of the communications equipment.			
Rated maximum output power of transmitter (W)	Separation distance according to frequency of transmitter (m)		
	150 kHz to 80 MHz $d = 1.2\sqrt{P}$	80 MHz to 800 MHz $d = 1.2\sqrt{P}$	800 MHz to 2.5 GHz $d = 2.3\sqrt{P}$
0.01	0.12	0.12	0.23
0.1	0.38	0.38	0.73
1	1.2	1.2	2.3
10	3.8	3.8	7.3
100	12	12	23
For transmitters rated at a maximum output power not listed above, the recommended separation distance $d$ in metres (m) can be estimated using the equation applicable to the frequency of the transmitter, where $P$ is the maximum output power rating of the transmitter in watts (W) according to the transmitter manufacturer.			
NOTE 1 At 80 MHz and 800 MHz, the separation distance for the higher frequency range applies.			
NOTE 2 These guidelines may not apply in all situations. Electromagnetic propagation is affected by absorption and reflection from structures, objects and people.			

**Table 5-4. Recommended Separation Distances**

## RF Transmitters



The KXL System contains an RFID function which transmits and receives at the 13.56 MHz frequency. This functionality may be interfered with by other equipment, even if that other equipment complies with CISPR emission requirements.

### 5.1.1 RFID Reader

- 13.56MHz Reader/Writer
- Integral Antenna: Maximum 4” Read Range
- US/FCC number SX90RFID1
- Max output power is 200mW
- Meets: ISO18000-3, ISO15693

The highest emissions generated by the above equipment are listed below:

Fundamental	Frequency (MHz)	Level (dB $\mu$ V/m) at 30 m	Limit (dB $\mu$ V/m) at 30 m	Limit ( $\mu$ V/m) at 30 m	Margin (dB)
Paragraph 15.225(a)	13.56 (peak)	29.8	84	15,848	-54.2











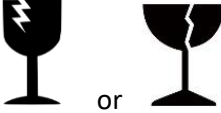
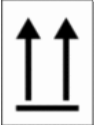
Other	Frequency (MHz)	Level (dB $\mu$ V/m)	Limit (dB $\mu$ V/m)	Margin (dB)
Harmonics	27.12 (peak)	-5.2	29.5	-34.7
Spurious	200.6 (peak)	34.5	40.0	-5.5
Conducted	0.199 (avg)	38.8	54.6	-15.8

*Table 5-5. Highest Emissions*

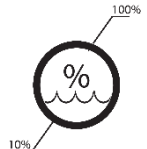



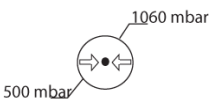
### 5.1.2 Wireless Remote Control

- FCC ID SXJ87027-TX
- Frequency Range 2405MHz to 2475MHz
- Emissions Compliant with 47 CFR Part 15

# 6 Symbol Library

Text Symbol	Symbol Illustration	Definition
1. No AP symbol in presence of flammable anesthetics		Danger, Risk of Explosion. Not for use
2. AC symbol		Alternating current
3. "i" in a book		Attention: Consult ACCOMPANYING DOCUMENTS
4. Ground symbol in circle		Protected earth (ground)
5. Power Switch		ON
6. Power Switch		OFF
7. Fuse symbol		Fuse
8. Manufacturer		Name and address of the manufacturer
9. ! in a Triangle		Caution specific warning in operators manual
10. Net Weight (kgs) Gross Weight (kgs)	NW GW	Weight
11. Umbrella with raindrops		Keep Dry: Store protected from moisture (symbol is with or without rain drops)
12. Wine glass with crack on it		Contents are fragile, handle with care
13. Two up arrows		Keep arrows on carton pointing up



Text Symbol	Symbol Illustration	Definition
14. Water drop in a box		Humidity limits (percentages below symbol are the acceptable range for humidity)
15. Temperature limits		Temperature shipment limits
16. MR crossed in a circle		MR Unsafe – Keep away from magnetic resonance imaging (MRI) equipment
17. Signal emitted		This device includes RF transmitters
18. Pressure limits		Atmospheric pressure limits (storage / operating)

## 7 Specifications

Specification	Description
<b>Electrical</b>	Battery Powered: 12V 35 Ah SLA Line voltages 100 – 240 volts AC Current: 2A – 1A Single Phase RMS, 50/60 Hz Remote 2x AAA batteries
<b>User accessible Fuses</b>	250 V~ T2AH
<b>Energy Delivery</b>	UV Radiation 3 – 45 mW/cm <sup>2</sup> ±10% 365 nm
<b>UVA LED Light Source</b>	UV Radiation 365 nm
<b>External Interfaces</b>	USB 2.0
<b>Physical Dimensions</b>	No larger than 60 x 60 x 150 cm <sup>3</sup> (Length x Width x Height)
<b>Weight (crated system)</b>	NW 45 Kg GW 120 Kg
<b>System Battery Life (normal operating conditions)</b>	16 hours
<b>Remote Battery Life (normal operating conditions)</b>	18 hours
<b>Environmental Operating Conditions</b>	The system operates under the following atmospheric conditions (no condensation).
<b>Ambient temperature</b>	+10 to +40 °C
<b>Relative humidity</b>	30% to 75%, non-condensing
<b>Atmospheric pressure</b>	700 to 1060 mbar
<b>Transport and Storage Conditions</b>	The instrument withstands the following transport and storage conditions without damage or performance deterioration.
<b>Ambient temperature</b>	-15 to +70 °C
<b>Relative humidity</b>	10% to 100% non-condensing
<b>Atmospheric pressure</b>	500 to 1060 mbar